



# Cross-Roller Ring

THK General Catalog

## A Product Descriptions

<b>Features and Types</b> .....	A18-2
Features of the Cross-Roller Ring .....	A18-2
• Structure and Features .....	A18-2
Types of the Cross-Roller Ring .....	A18-5
• Types and Features .....	A18-5
<b>Point of Selection</b> .....	A18-7
Selecting a Cross-Roller Ring .....	A18-7
Nominal Life .....	A18-8
Static Safety Factor .....	A18-10
Static Permissible Moment .....	A18-11
Static Permissible Axial Load .....	A18-11
Accuracy Standards .....	A18-12
• Accuracy Standard of the USP-Grade Series ..	A18-16
Radial Clearance .....	A18-17
Moment Rigidity .....	A18-18
<b>Dimensional Drawing, Dimensional Table</b>	
Model RU (Integrated Inner/Outer Ring Type) ..	A18-20
Model RB (Separable Outer Ring Type) ..	A18-22
Model RE (Two-piece Inner Ring Type) ..	A18-25
USP-Grade Models RB and RE .....	A18-28
Model RA (Separable Outer Ring Type) ..	A18-29
Model RA-C (Single-Split Type) .....	A18-30
<b>Point of Design</b> .....	A18-31
Fit .....	A18-31
Designing the Housing and the Presser Flange ..	A18-32
<b>Model No.</b> .....	A18-35
• Model Number Coding .....	A18-35
<b>Precautions on Use</b> .....	A18-36

## B Support Book (Separate)

<b>Features and Types</b> .....	B18-2
Features of the Cross-Roller Ring .....	B18-2
• Structure and Features .....	B18-2
Types of the Cross-Roller Ring .....	B18-5
• Types and Features .....	B18-5
<b>Point of Selection</b> .....	B18-7
Selecting a Cross-Roller Ring .....	B18-7
Nominal Life .....	B18-8
Static Safety Factor .....	B18-10
• Example of calculation (1): Horizontal Installation ..	B18-11
• Example of calculation (2): Vertical Installation .....	B18-12
Static Permissible Moment .....	B18-13
• Example of Calculating a Static Permissible Moment ..	B18-13
Static Permissible Axial Load .....	B18-13
• Example of Calculating a Static Permissible Axial Load ..	B18-13
<b>Mounting Procedure</b> .....	B18-14
Procedure for Assembly .....	B18-14
<b>Model No.</b> .....	B18-15
• Model Number Coding .....	B18-15
<b>Precautions on Use</b> .....	B18-16

## Features of the Cross-Roller Ring

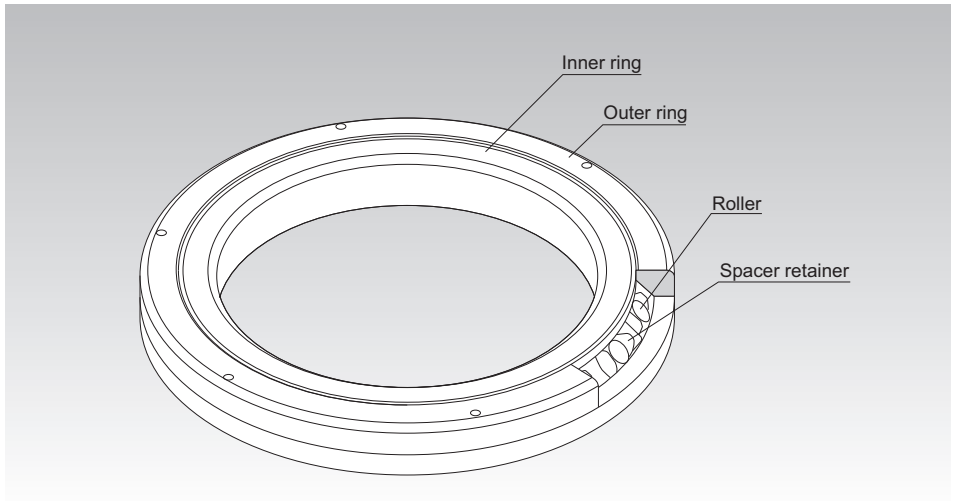

Fig.1 Structure of Cross Roller-Ring Model RB

---

### Structure and Features

---

With the Cross-Roller Ring, cylindrical rollers are arranged with each roller perpendicular to the adjacent roller, in a  $90^\circ$  V groove, separated from each other by a spacer retainer. This design allows just one bearing to receive loads in all directions including radial, axial and moment loads.

Since the Cross-Roller Ring achieves high rigidity despite the minimum possible dimensions of the inner and outer rings, it is optimal for applications such as joints and swiveling units of industrial robots, swiveling tables of machining centers, rotary units of manipulators, precision rotary tables, medical equipment, measuring instruments and IC manufacturing machines.

#### [High Rotation Accuracy]

The spacer retainer fitting among cross-arrayed rollers prevents rollers from skewing and the rotational torque from increasing due to friction between rollers. Unlike conventional types using steel sheet retainers, the Cross-Roller Ring does not cause unilateral contact of roller or seize. Thus, even under a preload, the Cross-Roller Ring provides stable rotation.

Since the inner and outer rings are designed to be separable, the preload can be adjusted, and this feature enables accurate rotation.

**[Easy Handling]**

The inner and outer rings, which are separable, are secured to the Cross-Roller Ring body after being installed with rollers and spacer retainers in order to prevent the rings from separating from each other. Thus, it is easy to handle the rings when installing the Cross-Roller Ring.

**[Skewing Prevention]**

The spacer retainer keeps rollers in their proper position, thereby preventing them from skewing (tilted rollers). This eliminates friction between rollers, and therefore secures a stable rotational torque.

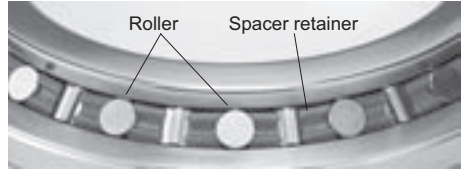

**[Increased Rigidity (Three to Four Times Greater than the Conventional Type)]**

Unlike the thin angular ball bearings installed in double rows, the cross array of rollers allows a single Cross-Roller Ring unit to receive loads in all directions, increasing the rigidity to three to four times greater than the conventional type.

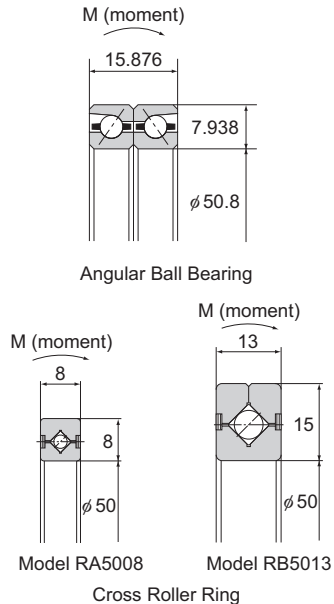
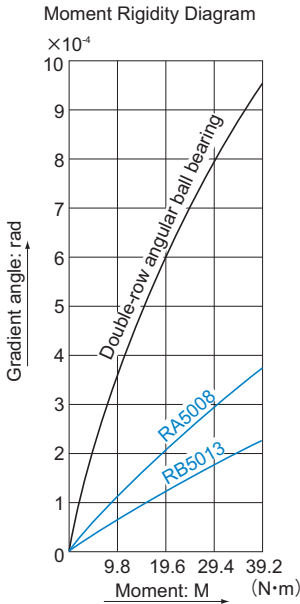

### [Large Load Capacity]

(1) Compared with conventional steel sheet retainers, the spacer retainer allows a longer effective contact length of each roller, thus significantly increasing the load capacity.

The spacer retainer guides rollers by supporting them over the entire length of each roller, whereas the conventional type of retainer supports them only at a point at the center of each roller. Such one-point contact cannot sufficiently prevent skewing.

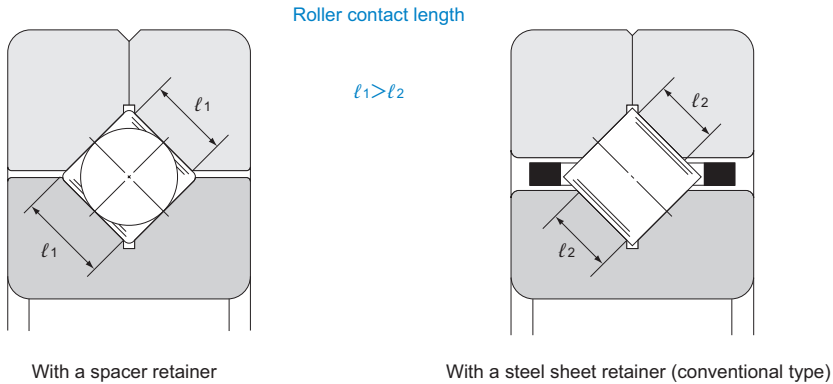

(2) In conventional types, the loaded areas are asymmetrical between the outer ring and the inner ring sides around the roller longitudinal axis. The greater the applied load is, the greater the moment becomes, leading end-face contact to occur. This causes frictional resistance, which hinders smooth rotation and quickens wear.

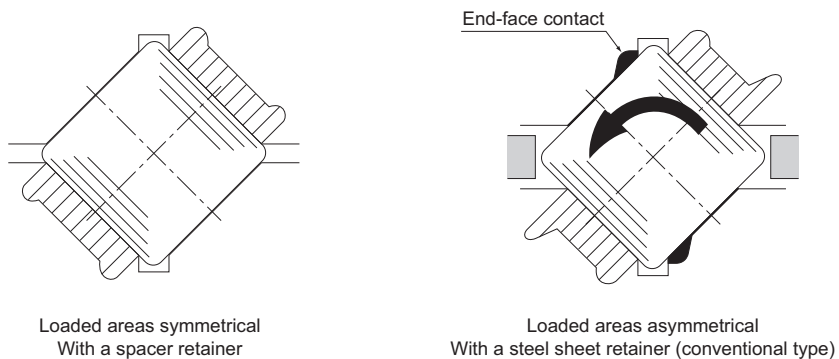

# Types of the Cross-Roller Ring

## Types and Features

### Model RU (Integrated Inner/Outer Ring Type)

Specification Table⇒ **A 18-20**

The integrated design of the unit's inner and outer rings, with mounting holes on both rings, eliminates the need for a special flange or housing and enables easy installation. Mounting has virtually no effect on performance, which ensures stable, accurate rotation and torque. Can be used for both outer and inner ring rotation.

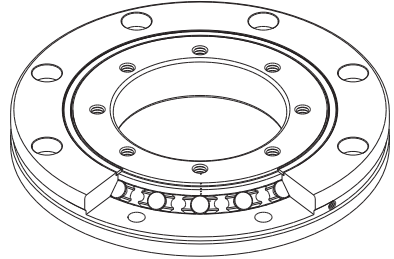

Model RU

### Model RB (Separable Outer Ring Type for Inner Ring Rotation)

Specification Table⇒ **A 18-22**

Cross-Roller Ring basic type, with a separable outer ring, and an inner ring integrated with the main body. It is used in locations where the rotational accuracy of the inner ring is required. It is used, for example, in the swivel portions of index tables of machine tools.

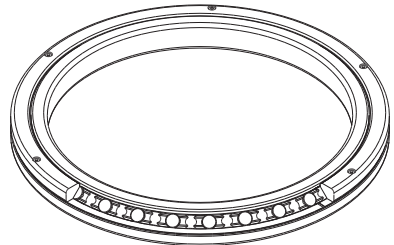

Model RB

### Model RE (Two-piece Inner Ring Type for Outer Ring Rotation)

Specification Table⇒ **A 18-25**

Main dimensions are the same as model RB. This model is used in locations where the rotational accuracy of the outer ring is required.

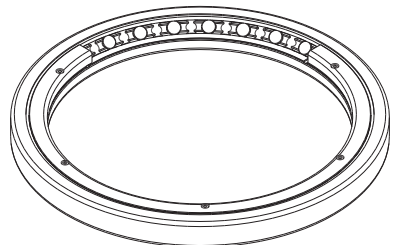

Model RE

## USP-Grade Series of Models RB and RE

Specification Table⇒ **A18-28**

The rotation accuracy of the USP-Grade Series achieves the ultra precision grade that surpasses the world's highest accuracy standards such as JIS Class 2, ISO Class 2, DIN P2 and AFBMA ABCE9.

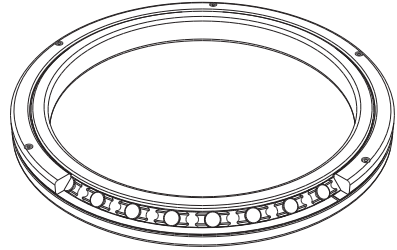

## Model RA (Separable Outer Ring Type for Inner Ring Rotation)

Specification Table⇒ **A18-29**

A compact type similar to model RB with the thinnest possible inner and outer rings. Optimal for locations requiring a light-weight and compact design such as the swivel portions of robots and manipulators.

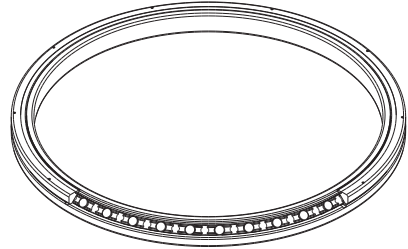

Model RA

## Model RA-C (Single-Split Type)

Specification Table⇒ **A18-30**

The main dimensions are the same as that of model RA. Owing to its Single-split Outer Ring structure with a highly rigid outer ring, this model can be used for outer ring rotation.

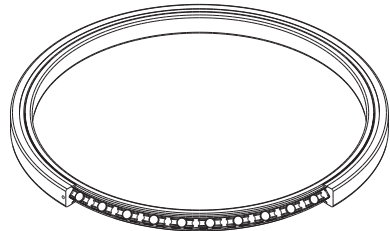

Model RA-C

## Selecting a Cross-Roller Ring

The following diagram shows a typical procedure for selecting a Cross-Roller Ring.

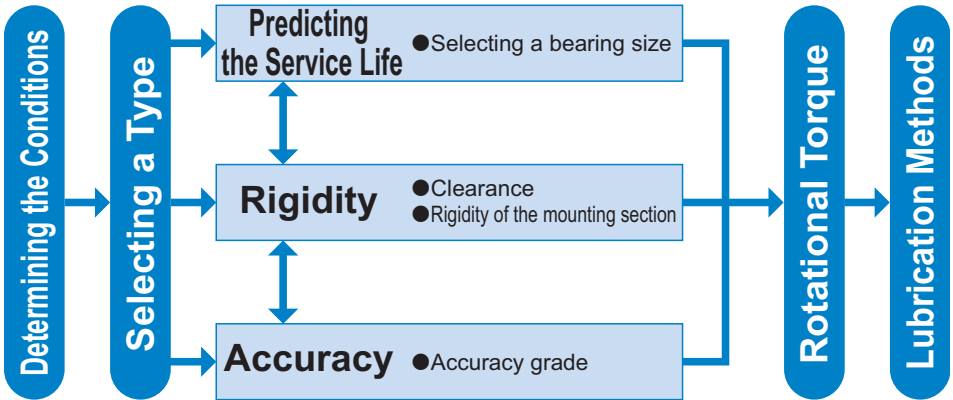

- Inner ring rotating……Model RB
- Outer ring rotating……Model RE
- Mounting space……Models RA-C and RA

# Nominal Life

## [Nominal Life]

The service life of the Cross-Roller Ring is obtained from the following equation.

$$L = \left( \frac{f_T \cdot C}{f_w \cdot P_c} \right)^{\frac{10}{3}} \times 10^6$$

- L** : Nominal life  
 (The total number of revolutions that 90% of a group of identical Cross-Roller Ring units independently operating under the same conditions can achieve without showing flaking from rolling fatigue)
- C** : Basic dynamic load rating\* (N)
- P<sub>c</sub>** : Dynamic equivalent radial load (N)  
 (see **A18-9**)
- f<sub>T</sub>** : Temperature factor (see Fig. 1)
- f<sub>w</sub>** : Load factor (see Table1)

\* The basic dynamic load rating (C) refers to a radial load of unvarying direction and magnitude for which the rated life (L) is 1 million revolutions, based on a group of identical Cross-Roller Rings operating independently under identical conditions. Basic dynamic load ratings are shown in the dimensional tables.

\* Rated life is calculated according to load and presumes optimal mounting conditions and adequate lubrication. Usage involving back-and-forth motion or low-speed operation may affect lubrication requirements. Please consult THK for assistance in calculating service life for usage involving back-and-forth motion or low-speed operation.

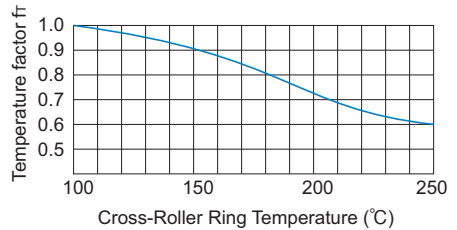

Fig.1 Temperature Factor (f<sub>T</sub>)

Note) The normal service temperature is 80°C or below. If the product is to be used at a higher temperature, contact THK.

## [f<sub>w</sub>:Load Factor]

Machines that perform rotary movements are often subjected to vibration and impact during operation. It is difficult to accurately identify the cause of vibration from a motor, gears, or other drive components, or of impact arising from frequent starts and stops.

In the event of excessive vibration or impact, divide the basic dynamic load rating (C) by the corresponding load factor, using the empirically obtained figures in Table1 as guidelines.

Table1 Load Factor (f<sub>w</sub>)

Service condition	f <sub>w</sub>
Smooth motion without impact	1 to 1.2
Normal motion	1.2 to 1.5
Excessive vibration or impact	1.5 to 3



[Calculating the Service Life Time]

● For Rotary Motion

$$L_h = \frac{L}{N \times 60}$$

$L_h$  : Service life time (h)  
 $N$  : Rotation speed per minute ( $\text{min}^{-1}$ )

● For Oscillatory Motion

$$L_h = \frac{360 \times L}{2 \times \theta \times n_r \times 60}$$

$L_h$  : Service life time (h)  
 $\theta$  : Rocking angle (deg.)  
 (\* see figure at right)  
 $n_r$  : Number of reciprocations per minute ( $\text{min}^{-1}$ )

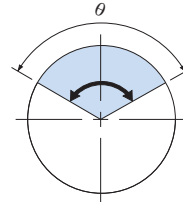

\* Rocking angle: If  $\theta$  is too small, this will hinder the formation of an oil film on the contact surfaces between the race and the roller and may cause fretting. If the product will be used in these conditions, contact THK.

[Dynamic Equivalent Radial Load  $P_c$ ]

The dynamic equivalent radial load of the Cross-Roller Ring is obtained from the following equation.

$$P_c = X \cdot \left( F_r + \frac{2M}{dp} \right) + Y \cdot F_a$$

$P_c$  : Dynamic equivalent radial load (N)  
 $F_r$  : Radial load (N)  
 $F_a$  : Axial load (N)  
 $M$  : Moment (N-mm)  
 $X$  : Dynamic radial factor (see Table2)  
 $Y$  : Dynamic axial factor (see Table2)  
 $dp$  : Roller pitch circle diameter (mm)

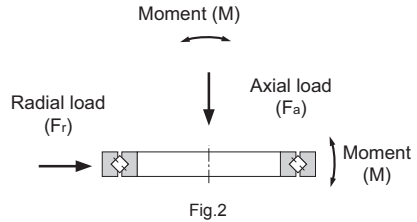

Fig.2

Table2 Dynamic Radial Factor and Dynamic Axial Factor

Classification	X	Y
$\frac{F_a}{F_r + 2M/dp} \leq 1.5$	1	0.45
$\frac{F_a}{F_r + 2M/dp} > 1.5$	0.67	0.67

- If  $F_r = 0\text{N}$  and  $M = 0\text{ N-mm}$ , perform calculation while assuming that  $X = 0.67$  and  $Y = 0.67$ .
- For service life calculation with a preload taken into account, contact THK.

# Static Safety Factor

The basic static load rating  $C_0$  refers to the static load with constant direction and magnitude, under which the calculated contact stress in the center of the contact area between the roller and the raceway under the maximum load is 4000 MPa. (If the contact stress exceeds this level, it will affect the rotation.) This value is indicated as “ $C_0$ ” in the specification tables. When a load is statically or dynamically applied, it is necessary to consider the static safety factor as shown below.

$$\frac{C_0}{P_0} = f_s$$

- $f_s$  : Static safety factor (see Table3)
- $C_0$  : Basic static load rating (N)
- $P_0$  : Static equivalent radial load (N)

Table3 Static Safety Factor ( $f_s$ )

Load conditions	Lower limit of $f_s$
Normal load	1 to 2
Impact load	2 to 3

\* Target minimum values for the static safety factor are shown in the table above. For better service life and other aspects of dynamic performance, THK recommends maintaining a figure of 7 or above.

## [Static Equivalent Radial Load $P_0$ ]

The static equivalent radial load of the Cross-Roller Ring is obtained from the following equation.

$$P_0 = X_0 \cdot \left( F_r + \frac{2M}{dp} \right) + Y_0 \cdot F_a$$

- $P_0$  : Static equivalent radial load (N)
- $F_r$  : Radial load (N)
- $F_a$  : Axial load (N)
- $M$  : Moment (N-mm)
- $X_0$  : Static radial factor ( $X_0=1$ )
- $Y_0$  : Static axial factor ( $Y_0=0.44$ )
- $dp$  : Roller pitch circle diameter (mm)

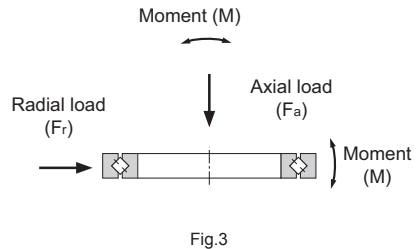

## Static Permissible Moment

The static permissible moment ( $M_0$ ) of the Cross-Roller Ring is obtained from the following equation.

$$M_0 = C_0 \cdot \frac{dp}{2} \times 10^{-3}$$

- $M_0$  : Static Permissible Moment (kN-m)  
 $C_0$  : Basic static load rating (kN)  
 $dp$  : Roller pitch circle diameter (mm)

## Static Permissible Axial Load

The static permissible axial load ( $F_{a0}$ ) of the Cross-Roller Ring is obtained from the following equation.

$$F_{a0} = \frac{C_0}{Y_0}$$

- $F_{a0}$  : Static permissible axial load (kN)  
 $Y_0$  : Static axial factor ( $Y_0=0.44$ )

# Accuracy Standards

The Cross-Roller Ring is manufactured with the accuracy and the dimensional tolerance according to Table4 to Table13.

Table4 Rotational Accuracy of the Inner Ring of Model RU

Unit:  $\mu\text{m}$

Model No.	Radial runout tolerance of the inner ring			Axial runout tolerance of the inner ring		
	Grade P5	Grade P4	Grade P2	Grade P5	Grade P4	Grade P2
RU42	4	3	2.5	4	3	2.5
RU66	5	4	2.5	5	4	2.5
RU85	5	4	2.5	5	4	2.5
RU124	5	4	2.5	5	4	2.5
RU148	6	5	2.5	6	5	2.5
RU178	6	5	2.5	6	5	2.5
RU228	8	6	5	8	6	5
RU297	10	8	5	10	8	5
RU445	15	12	7	15	12	7

Note1) For model RU, grade P5 is standard rotational accuracy.(Not indicated in model number.)

Note2) For the rotational accuracy of a special type or other types not shown above, contact THK. (Unless otherwise specified, rotational accuracy grade 0 of models RB and RE will be applied.)

Table5 Rotational Accuracy of the Outer Ring of Model RU

Unit:  $\mu\text{m}$

Model No.	Radial runout tolerance of the outer ring			Axial runout tolerance of the outer ring		
	Grade P5	Grade P4	Grade P2	Grade P5	Grade P4	Grade P2
RU42	8	5	4	8	5	4
RU66	10	6	5	10	6	5
RU85	10	6	5	10	6	5
RU124	13	8	5	13	8	5
RU148	15	10	7	15	10	7
RU178	15	10	7	15	10	7
RU228	18	11	7	18	11	7
RU297	20	13	8	20	13	8
RU445	25	16	10	25	16	10

Note1) For model RU, grade P5 is standard rotational accuracy.(Not indicated in model number.)

Note2) For the rotational accuracy of a special type or other types not shown above, contact THK. (Unless otherwise specified, rotational accuracy grade 0 of models RB and RE will be applied.)

Table6 Rotational Accuracy of the Inner Ring of Model RB

Unit: μm

Nominal dimension of the bearing inner diameter (d) (mm)		Radial runout tolerance of the inner ring					Axial runout tolerance of the inner ring				
		Grade 0	Grade PE6	Grade PE5	Grade PE4	Grade PE2	Grade 0	Grade PE6	Grade PE5	Grade PE4	Grade PE2
			Grade P6	Grade P5	Grade P4	Grade P2		Grade P6	Grade P5	Grade P4	Grade P2
Above	Or less										
18	30	13	8	4	3	2.5	13	8	4	3	2.5
30	50	15	10	5	4	2.5	15	10	5	4	2.5
50	80	20	10	5	4	2.5	20	10	5	4	2.5
80	120	25	13	6	5	2.5	25	13	6	5	2.5
120	150	30	18	8	6	2.5	30	18	8	6	2.5
150	180	30	18	8	6	5	30	18	8	6	5
180	250	40	20	10	8	5	40	20	10	8	5
250	315	50	25	13	10	(6)	50	25	13	10	(6)
315	400	60	30	15	12	(7)	60	30	15	12	(7)
400	500	65	35	18	14	(9)	65	35	18	14	(9)
500	630	70	40	20	16	(10)	70	40	20	16	(10)
630	800	80	(45)	(23)	(18)	(11)	80	(45)	(23)	(18)	(11)
800	1000	90	(50)	(25)	(20)	(12)	90	(50)	(25)	(20)	(12)
1000	1250	100	(55)	(28)	(22)	—	100	(55)	(28)	(22)	—

Note) The values in parentheses are available only on special orders. Contact THK for details.

Table7 Rotational Accuracy of the Outer Ring of Model RE

Unit: μm

Nominal dimension of the bearing outer diameter (D) (mm)		Radial runout tolerance of the outer ring					Axial runout tolerance of the outer ring				
		Grade 0	Grade PE6	Grade PE5	Grade PE4	Grade PE2	Grade 0	Grade PE6	Grade PE5	Grade PE4	Grade PE2
			Grade P6	Grade P5	Grade P4	Grade P2		Grade P6	Grade P5	Grade P4	Grade P2
Above	Or less										
30	50	20	10	7	5	2.5	20	10	7	5	2.5
50	80	25	13	8	5	4	25	13	8	5	4
80	120	35	18	10	6	5	35	18	10	6	5
120	150	40	20	11	7	5	40	20	11	7	5
150	180	45	23	13	8	5	45	23	13	8	5
180	250	50	25	15	10	7	50	25	15	10	7
250	315	60	30	18	11	7	60	30	18	11	7
315	400	70	35	20	13	8	70	35	20	13	8
400	500	80	40	23	15	(9)	80	40	23	15	(9)
500	630	100	50	25	16	(10)	100	50	25	16	(10)
630	800	120	60	30	20	(13)	120	60	30	20	(13)
800	1000	120	75	(38)	(25)	(16)	120	75	(38)	(25)	(16)
1000	1250	120	(75)	(40)	(27)	(18)	120	(75)	(40)	(27)	(18)
1250	1600	120	(75)	(42)	(30)	(20)	120	(75)	(42)	(30)	(20)

Note) The values in parentheses are available only on special orders. Contact THK for details.

Table8 Rotational Accuracy of the Inner Ring of Model RA and RA-C

Unit: μm

Nominal dimension of the bearing inner diameter (d) (mm)		Tolerance in radial runout and axial runout
Above	Or less	
40	65	13
65	80	15
80	100	15
100	120	20
120	140	25
140	180	25
180	200	30

Table9 Rotational Accuracy of the Outer Ring of Model RA-C

Unit: μm

Nominal dimension of the bearing outer diameter (D) (mm)		Tolerance in radial runout and axial runout
Above	Or less	
65	80	13
80	100	15
100	120	15
120	140	20
140	180	25
180	200	25
200	250	30

Note) If higher accuracy than the above values is required for the inner ring in rotational accuracy for models RA and RA-C, contact THK.

Note) The rotational accuracy of the outer ring for model RA-C indicates the value before separation.

Table10 Dimensional Tolerance of the Bearing Inner Diameter

Unit:  $\mu\text{m}$ 

Nominal dimension of the bearing inner diameter (d) (mm)		Tolerance of $d_m$ <sup>(note 2)</sup>							
		Grades 0, P6, P5, P4, P2 and USP		Grade PE6		Grade PE5		Grade PE4 and PE2	
Above	Or less	Upper	Lower	Upper	Lower	Upper	Lower	Upper	Lower
18	30	0	-10	0	-8	0	-6	0	-5
30	50	0	-12	0	-10	0	-8	0	-6
50	80	0	-15	0	-12	0	-9	0	-7
80	120	0	-20	0	-15	0	-10	0	-8
120	150	0	-25	0	-18	0	-13	0	-10
150	180	0	-25	0	-18	0	-13	0	-10
180	250	0	-30	0	-22	0	-15	0	-12
250	315	0	-35	0	-25	0	-18	—	—
315	400	0	-40	0	-30	0	-23	—	—
400	500	0	-45	0	-35	—	—	—	—
500	630	0	-50	0	-40	—	—	—	—
630	800	0	-75	—	—	—	—	—	—
800	1000	0	-100	—	—	—	—	—	—
1000	1250	0	-125	—	—	—	—	—	—

Note1) Standard inner diameter accuracy of models RA, RA-C and RU is 0. For higher accuracy than 0, contact THK.

Note2) "dm" represents the arithmetic average of the maximum and minimum diameters obtained in measuring the bearing inner diameter at two points.

Note3) For accuracy grades in bearing inner diameter with no values indicated in the table, the highest value among low accuracy grades applies.

Table11 Dimensional Tolerance of the Bearing Outer Diameter

Unit:  $\mu\text{m}$ 

Nominal dimension of the bearing outer diameter (D) (mm)		Tolerance of $D_m$ <sup>(note 2)</sup>							
		Grades 0, P6, P5, P4, P2 and USP		Grade PE6		Grade PE5		Grade PE4 and PE2	
Above	Or less	Upper	Lower	Upper	Lower	Upper	Lower	Upper	Lower
30	50	0	-11	0	-9	0	-7	0	-6
50	80	0	-13	0	-11	0	-9	0	-7
80	120	0	-15	0	-13	0	-10	0	-8
120	150	0	-18	0	-15	0	-11	0	-9
150	180	0	-25	0	-18	0	-13	0	-10
180	250	0	-30	0	-20	0	-15	0	-11
250	315	0	-35	0	-25	0	-18	0	-13
315	400	0	-40	0	-28	0	-20	0	-15
400	500	0	-45	0	-33	0	-23	—	—
500	630	0	-50	0	-38	0	-28	—	—
630	800	0	-75	0	-45	0	-35	—	—
800	1000	0	-100	—	—	—	—	—	—
1000	1250	0	-125	—	—	—	—	—	—
1250	1600	0	-160	—	—	—	—	—	—

Note1) Standard outer diameter accuracy of models RA, RA-C and RU is 0. For higher accuracy than 0, contact THK.

Note2) "Dm" represents the arithmetic average of the maximum and minimum diameters obtained in measuring the bearing outer diameter at two points.

Note3) For accuracy grades in bearing outer diameter with no values indicated in the table, the highest value among low accuracy grades applies.

Table12 Tolerance in the Width of the Inner and Outer Rings  
for Models RUUnit:  $\mu\text{m}$ 

Model No.	Tolerance of B	
	Upper	Lower
RU42	0	-75
RU66	0	-75
RU85	0	-75
RU124	0	-75
RU148	0	-75
RU178	0	-100
RU228	0	-100
RU297	0	-100
RU445	0	-150

Table13 Tolerance in the Width of the Inner and Outer Rings (Common to All Grades) for Models RB and RE

Unit:  $\mu\text{m}$ 

Nominal dimension of the bearing inner diameter (d) (mm)		Tolerance of B		Tolerance of B1	
		Applied to the inner ring of RB and the outer ring of RE		Applied to the outer ring of RB and the inner ring of RE	
Above	Or less	Upper	Lower	Upper	Lower
18	30	0	-75	0	-100
30	50	0	-75	0	-100
50	80	0	-75	0	-100
80	120	0	-75	0	-100
120	150	0	-100	0	-120
150	180	0	-100	0	-120
180	250	0	-100	0	-120
250	315	0	-120	0	-150
315	400	0	-150	0	-200
400	500	0	-150	0	-200
500	630	0	-150	0	-200
630	800	0	-150	0	-200
800	1000	0	-300	0	-400
1000	1250	0	-300	0	-400

Note) All B and B1 types of models RA and RA-C are manufactured with tolerance between -0.120 and 0.

## Accuracy Standard of the USP-Grade Series

### [Examples of Rotational Accuracy of the USP-Grade Series Cross-Roller Rings]

The rotation accuracy of the USP-Grade Series achieves the ultra precision grade that surpasses the world's highest accuracy standards such as JIS Class 2, ISO Class 2, DIN P2 and AFBMA ABEC9.

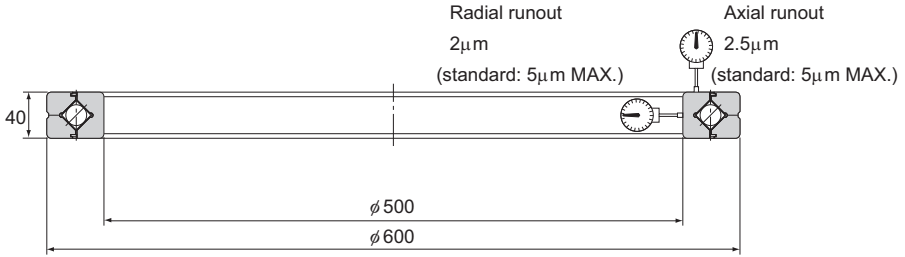

Rotational Accuracy of the Inner Ring of Model RB50040CC0USP

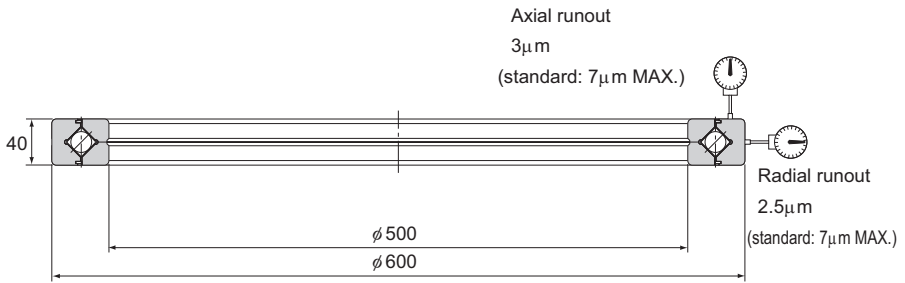

Rotational Accuracy of the Outer Ring of Model RE50040CC0USP

### [Accuracy Standards]

The USP-grade series of models RU, RB and RE are manufactured with runout accuracies according to Table14, Table15.

Table14 Runout Accuracies of the USP-grade Series of Models RU

Unit:  $\mu$ m

Model No.	Runout accuracy of the inner ring of model RU		Runout accuracy of the outer ring of model RU	
	Radial runout tolerance	Axial runout tolerance	Radial runout tolerance	Axial runout tolerance
RU 42	2	2	3	3
RU 66	2	2	3	3
RU 85	2	2	3	3
RU124	2	2	3	3
RU148	2	2	4	4
RU178	2	2	4	4
RU228	2.5	2.5	4	4
RU297	3	3	5	5
RU445	4	4	7	7

Table15 Runout Accuracies of the USP-grade Series of Models RB and RE

Unit:  $\mu$ m

Nominal inner diameter (d) and outer diameter (D) (mm)		Runout accuracy of the inner ring of model RB		Runout accuracy of the outer ring of model RE	
Above	Or less	Radial runout tolerance	Axial runout tolerance	Radial runout tolerance	Axial runout tolerance
80	180	2.5	2.5	3	3
180	250	3	3	4	4
250	315	4	4	4	4
315	400	4	4	5	5
400	500	5	5	5	5
500	630	6	6	7	7
630	800	—	—	8	8



# Radial Clearance

Table16 shows the radial clearance of model RU, Table17 that of the standard type of models RB and RE, Table18 that of the USP-grade series of models RB and RE, and Table19 that of the thin type of models RA and RA-C.

Table16 Radial clearance for model RU

Unit:  $\mu\text{m}$ 

Model No.	CC0		C0	
	Starting torque (N·m)		Radial clearance ( $\mu\text{m}$ )	
	Min.	Max.	Min.	Max.
RU42	0.1	0.5	0	25
RU66	0.3	2.2	0	30
RU85	0.4	3	0	40
RU124	1	6	0	40
RU148	1	10	0	40
RU178	3	15	0	50
RU228	5	20	0	60
RU297	10	35	0	70
RU445	20	55	0	100

Note) Model RU clearance CC0 is controlled by starting torque. Starting torque for clearance CC0 does not include seal resistance value.

Table17 Radial Clearances of Models RB and RE

Unit:  $\mu\text{m}$ 

Pitch circle diameter of the roller (dp) (mm)		CC0		C0		C1	
Above	Or less	Min.	Max.	Min.	Max.	Min.	Max.
18	30	-8	0	0	15	15	35
30	50	-8	0	0	25	25	50
50	80	-10	0	0	30	30	60
80	120	-10	0	0	40	40	70
120	140	-10	0	0	40	40	80
140	160	-10	0	0	40	40	90
160	180	-10	0	0	50	50	100
180	200	-10	0	0	50	50	110
200	225	-10	0	0	60	60	120
225	250	-10	0	0	60	60	130
250	280	-15	0	0	80	80	150
280	315	-15	0	30	100	100	170
315	355	-15	0	30	110	110	190
355	400	-15	0	30	120	120	210
400	450	-20	0	30	130	130	230
450	500	-20	0	30	130	130	250
500	560	-20	0	30	150	150	280
560	630	-20	0	40	170	170	310
630	710	-20	0	40	190	190	350
710	800	-30	0	40	210	210	390
800	900	-30	0	40	230	230	430
900	1000	-30	0	50	260	260	480
1000	1120	-30	0	60	290	290	530
1120	1250	-30	0	60	320	320	580
1250	1400	-30	0	70	350	350	630

Table18 Radial Clearances of USP-grade Series of Models RB and RE

Unit:  $\mu\text{m}$ 

Pitch circle diameter of the roller (dp) (mm)		CC0		C0	
Above	Or less	Min.	Max.	Min.	Max.
120	160	-10	0	0	40
160	200	-10	0	0	50
200	250	-10	0	0	60
250	280	-15	0	0	80
280	315	-15	0	0	100
315	355	-15	0	0	110
355	400	-15	0	0	120
400	500	-20	0	0	130
500	560	-20	0	0	150
560	630	-20	0	0	170
630	710	-20	0	0	190

Table19 Radial Clearances of Models RA and RA-C

Unit:  $\mu\text{m}$ 

Pitch circle diameter of the roller (dp) (mm)		CC0		C0	
Above	Or less	Min.	Max.	Min.	Max.
50	80	-8	0	0	15
80	120	-8	0	0	15
120	140	-8	0	0	15
140	160	-8	0	0	15
160	180	-10	0	0	20
180	200	-10	0	0	20
200	225	-10	0	0	20

# Moment Rigidity

Fig.4 to Fig.7 show moment rigidity diagrams for the Cross-Roller Ring as a separate unit. Rigidity is affected by the deformation of the housing, presser flange and bolts. Therefore, the strength of these parts must be taken into account.

(Radial clearance: 0)

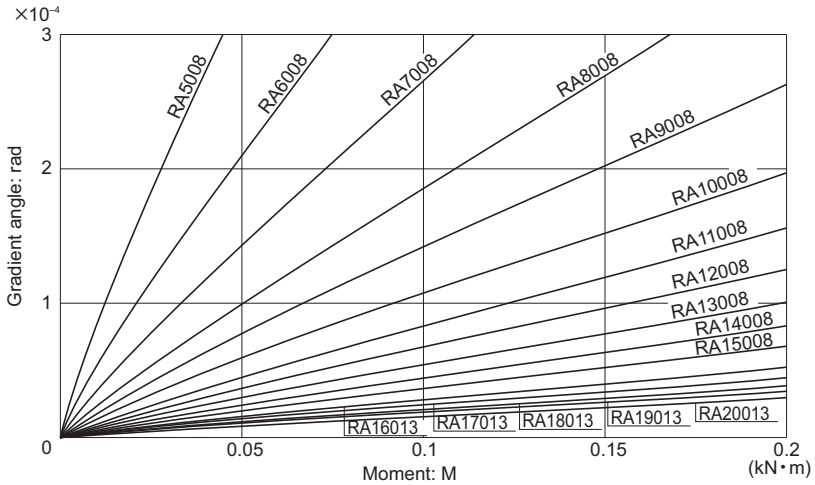

Fig.4

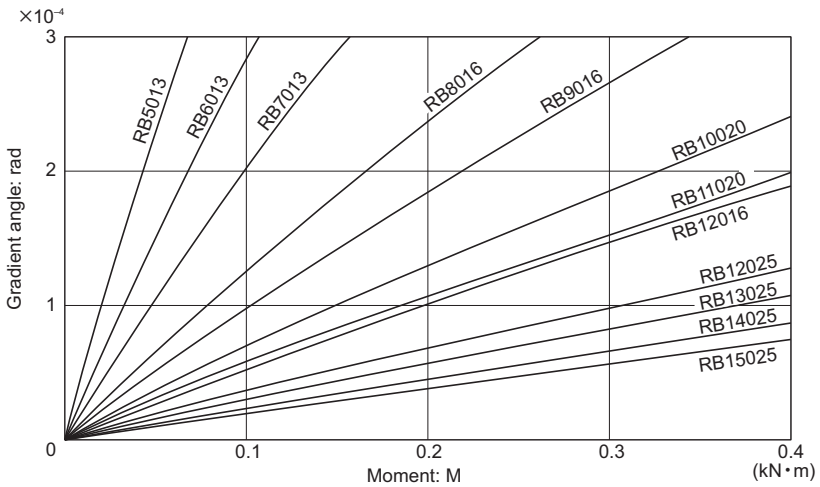

Fig.5

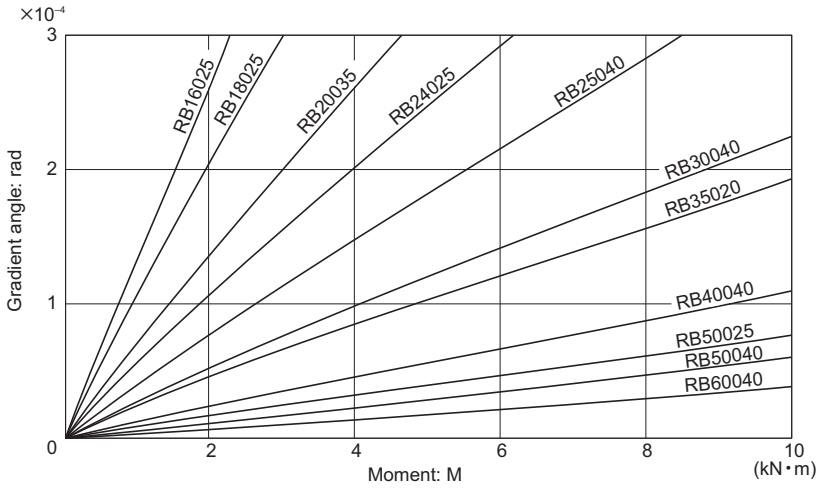

Fig.6

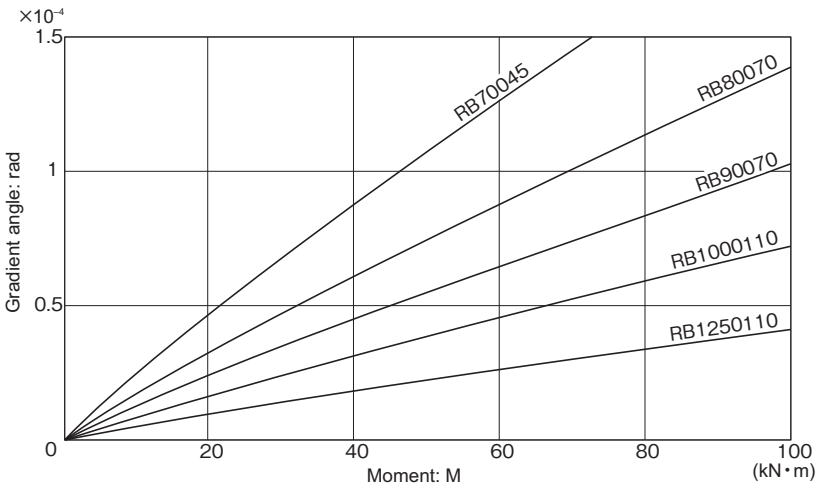
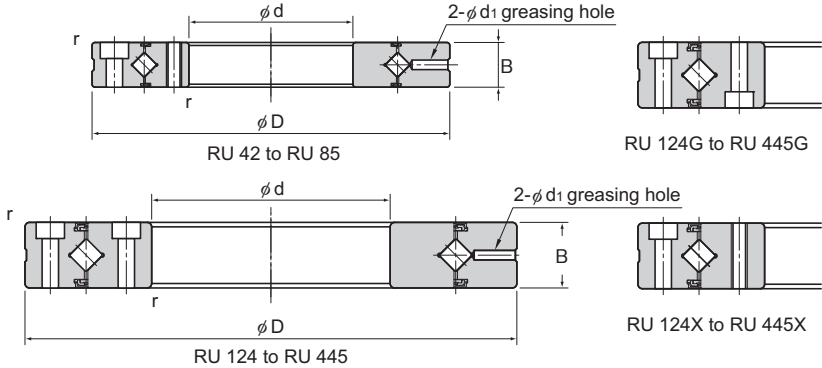

Fig.7

# Model RU (Integrated Inner/Outer Ring Type)



Shaft diameter	Model No.	Main dimensions						Shoulder height		Basic load rating (radial)		Mass
		Inner diameter	Outer diameter	Roller pitch circle diameter	Width	Greasing hole			C	C <sub>0</sub>		
		d	D	dp	B	d <sub>1</sub>	r <sub>min</sub>	ds (max)	Dh (min)	kN	kN	kg
20	RU 42	20	70	41.5	12	3.1	0.6	36	47	7.35	8.35	0.29
35	RU 66	35	95	66	15	3.1	0.6	59	74	17.5	22.3	0.62
55	RU 85	55	120	85	15	3.1	0.6	77	93	20.3	29.5	1
80	RU 124 (G)	80	165	124	22	3.1	1	114	134	33.1	50.9	2.6
	RU 124X											
90	RU 148 (G)	90	210	147.5	25	3.1	1.5	133	162	49.1	76.8	4.9
	RU 148X											
115	RU 178 (G)	115	240	178	28	3.1	1.5	161	195	80.3	135	6.8
	RU 178X											
160	RU 228 (G)	160	295	227.5	35	6	2	208	246	104	173	11.4
	RU 228X											
210	RU 297 (G)	210	380	297.3	40	6	2.5	272	320	156	281	21.3
	RU 297X											
350	RU 445 (G)	350	540	445.4	45	6	2.5	417	473	222	473	35.4
	RU 445X											

Note) Optional grease nipple available for model RU. (See figure below)  
Please indicate with a "-N" at the end of the model number if required.

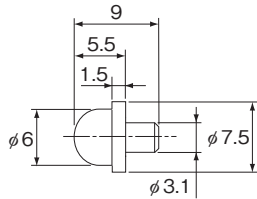

NP3.2×3.5

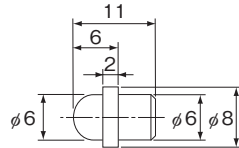

NP6×5

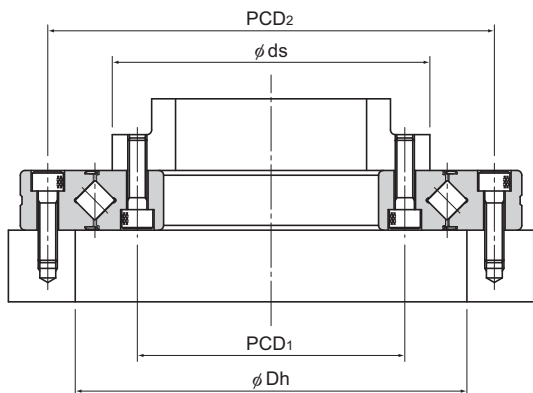

Model RU

Model RU...U



Model RU...UU

Model RU...UT

Unit: mm

Mounting Hole Related				
Inner ring			Outer ring	
PCD <sub>1</sub>	Mounting hole		PCD <sub>2</sub>	Mounting hole
28	6-M3 through		57	6-φ3.4 drilled through, φ6.5 counter bore depth 3.3
45	8-M4 through		83	8-φ4.5 drilled through, φ8 counter bore depth 4.4
65	8-M5 through		105	8-φ5.5 drilled through, φ9.5 counter bore depth 5.4
97	10-φ5.5 drilled through, φ9.5 counter bore depth 5.4 10-M5 through		148	10-φ5.5 drilled through, φ9.5 counter bore depth 5.4
112	12-φ9 drilled through, φ14 counter bore depth 8.6 12-M8 through		187	12-φ9 drilled through, φ14 counter bore depth 8.6
139	12-φ9 drilled through, φ14 counter bore depth 8.6 12-M8 through		217	12-φ9 drilled through, φ14 counter bore depth 8.6
184	12-φ11 drilled through, φ17.5 counter bore depth 10.8 12-M10 through		270	12-φ11 drilled through, φ17.5 counter bore depth 10.8
240	16-φ14 drilled through, φ20 counter bore depth 13 16-M12 through		350	16-φ14 drilled through, φ20 counter bore depth 13
385	24-φ14 drilled through, φ20 counter bore depth 13 24-M12 through		505	24-φ14 drilled through, φ20 counter bore depth 13

Cross-Roller Ring

**Model number coding**

**RU124 UU CC0 P2 B G X -N**

Model No.

Radial clearance symbol (\*1)

Accuracy symbol (\*2)

Sub-part Accuracy symbol

No Symbol : Rotational Accuracy of the Inner Ring

R : Rotational Accuracy of the Outer Ring

B : Rotational Accuracy of the Inner/Outer Rings

Option symbol

No Symbol : No accessory

-N : Grease nipple attached (For the nipple's shape, see the figure on the left.)

RU42 to RU178: NP3.2×3.5

RU228 to RU445: NP6×5

Seal symbol

No Symbol : Without seal

UU : Seal attached on both ends

U : Seal attached on either end (counterbore side of the outer ring)

UT : Seal attached on either end (opposite to the counterbore side of the outer ring)

Inner Ring Hole symbol

[Available models: RU124 to RU445]

No Symbol : Inner ring counterbore hole

X : Inner ring tapped hole (through hole)

Mounting Hole Orientation symbol

[Available models: RU124 to RU445 (excluding X type)]

No Symbol : The counterbore holes of the inner and outer rings face the same direction

G : The counterbore holes of the inner and outer rings face opposite direction

(\*1) See A18-17. (\*2) See A18-12.

# Model RB (Separable Outer Ring Type)

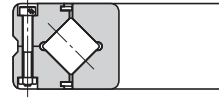
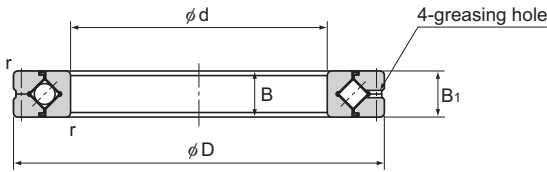

Model RB

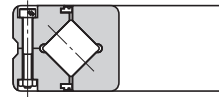
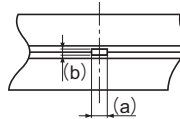
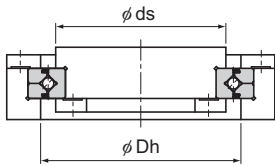

Model RB...UU

Detail view of the greasing hole

Unit: mm

Shaft diameter	Model No.	Main dimensions							Shoulder height		Basic load rating (radial)		Mass
		Inner diameter d	Outer diameter D	Roller pitch circle diameter dp	Width B B <sub>1</sub>	Greasing hole		$r_{min}$	ds (max)	Dh (min)	C kN	C <sub>0</sub> kN	kg
						a	b						
20	RB 2008	20	36	27	8	2	0.8	0.5	23.5	30.5	3.23	3.1	0.04
25	RB 2508	25	41	32	8	2	0.8	0.5	28.5	35.5	3.63	3.83	0.05
30	RB 3010	30	55	41.5	10	2.5	1	0.6	37	47	7.35	8.36	0.12
35	RB 3510	35	60	46.5	10	2.5	1	0.6	41	51.5	7.64	9.12	0.13
40	RB 4010	40	65	51.5	10	2.5	1	0.6	46.5	57.5	8.33	10.6	0.16
45	RB 4510	45	70	56.5	10	2.5	1	0.6	51	61.5	8.62	11.3	0.17
50	RB 5013	50	80	64	13	2.5	1.6	0.6	57	72	16.7	20.9	0.27
60	RB 6013	60	90	74	13	2.5	1.6	0.6	67	82	18	24.3	0.3
70	RB 7013	70	100	84	13	2.5	1.6	0.6	77	92	19.4	27.7	0.35
80	RB 8016	80	120	98	16	3	1.6	0.6	88	110	30.1	42.1	0.7
90	RB 9016	90	130	108	16	3	1.6	1	98	118	31.4	45.3	0.75
100	RB 10016	100	140	119.3	16	3.5	1.6	1	109	129	31.7	48.6	0.83
	RB 10020		150	123	20	3.5	1.6	1	113	133	33.1	50.9	1.45
110	RB 11012	110	135	121.8	12	2.5	1	0.6	117	128	12.5	24.1	0.4
	RB 11015		145	126.5	15	3.5	1.6	0.6	119	136	23.7	41.5	0.75
	RB 11020		160	133	20	3.5	1.6	1	120	143	34	54	1.56
120	RB 12016	120	150	134.2	16	3.5	1.6	0.6	127	141	24.2	43.2	0.72
	RB 12025		180	148.7	25	3.5	2	1.5	133	164	66.9	100	2.62
	RB 13015		130	160	144.5	15	3.5	1.6	0.6	137	152	25	46.7
RB 13025	190	158		25	3.5	2	1.5	143	174	69.5	107	2.82	

Note1) The model number of a type with seals attached is RB...UU.

If a certain level of accuracy is required, this model is used for inner ring rotation.

Note2) (a) and (b) dimensions of the greasing hole in the detailed diagram are reference values.

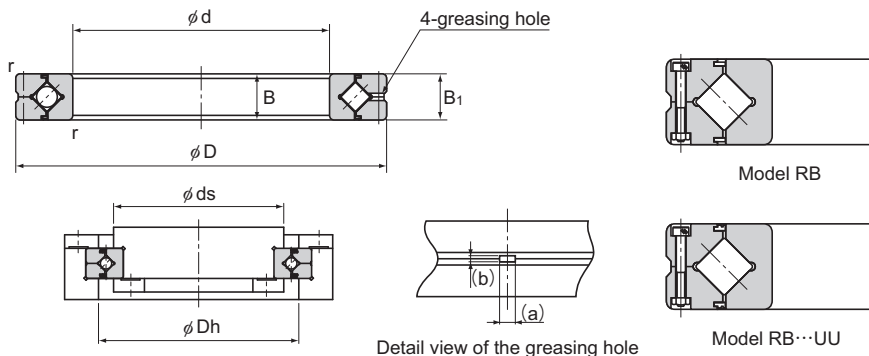

Unit: mm

Shaft diameter	Model No.	Main dimensions							Shoulder height		Basic load rating (radial)		Mass kg
		Inner diameter d	Outer diameter D	Roller pitch circle diameter dp	Width B B <sub>1</sub>	Greasing hole		r <sub>min</sub>	ds (max)	Dh (min)	C kN	C <sub>0</sub> kN	
						a	b						
140	RB 14016	140	175	154.8	16	2.5	1.6	1	147	162	25.9	50.1	1
	RB 14025		200	168	25	3.5	2	1.5	154	185	74.8	121	2.96
150	RB 15013	150	180	164	13	2.5	1.6	0.6	157	172	27	53.5	0.68
	RB 15025		210	178	25	3.5	2	1.5	164	194	76.8	128	3.16
	RB 15030		230	188	30	4.5	3	1.5	169	211	100	156	5.3
160	RB 16025	160	220	188.6	25	3.5	2	1.5	173	204	81.7	135	3.14
170	RB 17020	170	220	191	20	3.5	1.6	1.5	184	198	29	62.1	2.21
180	RB 18025	180	240	210	25	3.5	2	1.5	195	225	84	143	3.44
190	RB 19025	190	240	211.9	25	3.5	1.6	1	202	222	41.7	82.9	2.99
	RB 20025		260	230	25	3.5	2	2	215	245	84.2	157	4
200	RB 20030	200	280	240	30	4.5	3	2	221	258	114	200	6.7
	RB 20035		295	247.7	35	5	3	2	225	270	151	252	9.6
	RB 22025		220	280	250.1	25	3.5	2	2	235	265	92.3	171
240	RB 24025	240	300	269	25	3.5	2	2.5	256	281	68.3	145	4.5
250	RB 25025	250	310	277.5	25	3.5	2	2.5	265	290	69.3	150	5
	RB 25030		330	287.5	30	4.5	3	2.5	269	306	126	244	8.1
	RB 25040		355	300.7	40	6	3.5	2.5	275	326	195	348	14.8
300	RB 30025	300	360	328	25	3.5	2	2.5	315	340	76.3	178	5.9
	RB 30035		395	345	35	5	3	2.5	322	368	183	367	13.4
	RB 30040		405	351.6	40	6	3.5	2.5	326	377	212	409	17.2
350	RB 35020	350	400	373.4	20	3.5	1.6	2.5	363	383	54.1	143	3.9

Note1) The model number of a type with seals attached is RB...UU.

If a certain level of accuracy is required, this model is used for inner ring rotation.

Note2) (a) and (b) dimensions of the greasing hole in the detailed diagram are reference values.

### Model number coding

**RB3010 UU CC0 P5**

Model number

Accuracy symbol (\*2)

Radial clearance symbol (\*1)

Seal attached on both ends (seal attached on either end: U)

(\*1) See **A18-17**. (\*2) See **A18-13**.

# Model RB (Separable Outer Ring Type)

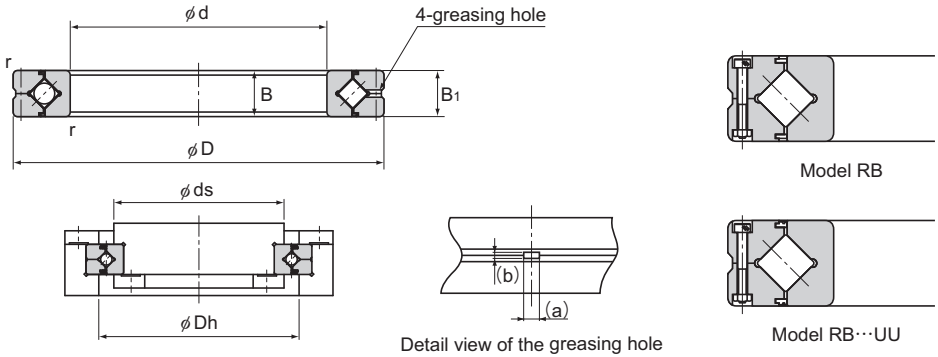

Unit: mm

Shaft diameter	Model No.	Main dimensions							Shoulder height		Basic load rating (radial)		Mass
		Inner diameter	Outer diameter	Roller pitch circle diameter	Width	Greasing hole		$r_{min}$	$ds$ (max)	$Dh$ (min)	C	$C_0$	
						$d$	$D$						
400	RB 40035	400	480	440.3	35	5	3	2.5	422	459	156	370	14.5
	RB 40040		510	453.4	40	6	3.5	2.5	428	479	241	531	23.5
450	RB 45025	450	500	474	25	3.5	1.6	1	464	484	61.7	182	6.6
	RB 50025		550	524.2	25	3.5	1.6	1	514	534	65.5	201	7.3
500	RB 50040	500	600	548.8	40	6	3	2.5	526	572	239	607	26
	RB 50050		625	561.6	50	6	3.5	2.5	536	587	267	653	41.7
	RB 60040		600	700	650	40	6	3	3	627	673	264	721
700	RB 70045	700	815	753.5	45	6	3	3	731	777	281	836	46
800	RB 80070	800	950	868.1	70	6	4	4	836	900	468	1330	105
900	RB 90070	900	1050	969	70	6	4	4	937	1001	494	1490	120
1000	RB 1000110	1000	1250	1114	110	6	6	5	1057	1171	1220	3220	360
1250	RB 1250110	1250	1500	1365.8	110	6	6	5	1308	1423	1350	3970	440

Note1) The model number of a type with seals attached is RB...UU.

If a certain level of accuracy is required, this model is used for inner ring rotation.

Note2) (a) and (b) dimensions of the greasing hole in the detailed diagram are reference values.

## Model number coding

**RB40040 UU C0 PE5**

Model number

Accuracy symbol (\*2)

Radial clearance symbol (\*1)

Seal attached on both ends (seal attached on either end: U)

(\*1) See **A18-17** . (\*2) See **A18-13**.



# Model RE (Two-piece Inner Ring Type)

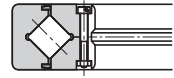
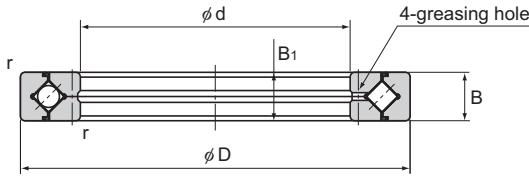

Model RE

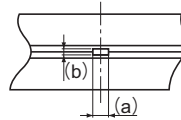
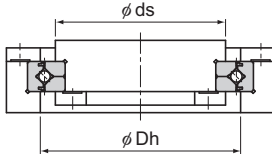

Detail view of the greasing hole

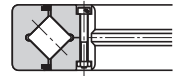

Model RE...UU

Unit: mm

Shaft diameter	Model No.	Main dimensions							Shoulder height		Basic load rating (radial)		Mass
		Inner diameter d	Outer diameter D	Roller pitch circle diameter dp	Width B B <sub>1</sub>	Greasing hole		r <sub>min</sub>	ds (max)	Dh (min)	C	C <sub>0</sub>	kg
						a	b						
20	RE 2008	20	36	29	8	2	0.8	0.5	24.5	32.5	3.23	3.1	0.04
25	RE 2508	25	41	34	8	2	0.8	0.5	29.5	37.5	3.63	3.83	0.05
30	RE 3010	30	55	43.5	10	2.5	1	0.6	37.5	48.5	7.35	8.36	0.12
35	RE 3510	35	60	48.5	10	2.5	1	0.6	42.5	53.5	7.64	9.12	0.13
40	RE 4010	40	65	53.5	10	2.5	1	0.6	47.5	58.5	8.33	10.6	0.16
45	RE 4510	45	70	58.5	10	2.5	1	0.6	52.5	63.5	8.62	11.3	0.17
50	RE 5013	50	80	66	13	2.5	1.6	0.6	57.5	73	16.7	20.9	0.27
60	RE 6013	60	90	76	13	2.5	1.6	0.6	68	83	18	24.3	0.3
70	RE 7013	70	100	86	13	2.5	1.6	0.6	78	93	19.4	27.7	0.35
80	RE 8016	80	120	101.4	16	3	1.6	0.6	91	111	30.1	42.1	0.7
90	RE 9016	90	130	112	16	3	1.6	1	100	122	31.4	45.3	0.75
100	RE 10016	100	140	121.1	16	3	1.6	1	109	131	31.7	48.6	0.83
	RE 10020		150	127	20	3.5	1.6	1	115	137	33.1	50.9	1.45
110	RE 11012	110	135	123.3	12	2.5	1	0.6	117	128	12.5	24.1	0.4
	RE 11015		145	129	15	3	1.6	0.6	122	136	23.7	41.5	0.75
	RE 11020		160	137	20	3.5	1.6	1	125	147	34	54	1.56
120	RE 12016	120	150	136	16	3	1.6	0.6	127	143	24.2	43.2	0.72
	RE 12025		180	152	25	3.5	2	1.5	135	166	66.9	100	2.62
	RE 13015		160	146	15	3	1.6	0.6	137	153	25	46.7	0.72
130	RE 13025	130	190	162	25	3.5	2	1.5	145	176	69.5	107	2.82

Note1) The model number of a type with seals attached is RE...UU.

If a certain level of accuracy is required, this model is used for outer ring rotation.

Note2) (a) and (b) dimensions of the greasing hole in the detailed diagram are reference values.

# Model RE (Two-piece Inner Ring Type)

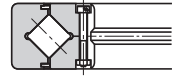
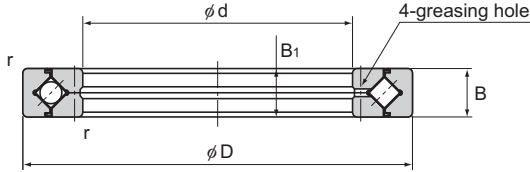

Model RE

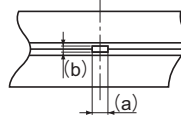
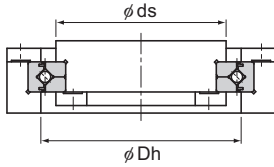

Detail view of the greasing hole

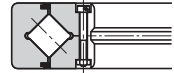

Model RE...UU

Unit: mm

Shaft diameter	Model No.	Main dimensions							Shoulder height		Basic load rating (radial)		Mass kg
		Inner diameter d	Outer diameter D	Roller pitch circle diameter dp	Width B B <sub>1</sub>	Greasing hole		r <sub>min</sub>	ds (max)	Dh (min)	C kN	C <sub>0</sub> kN	
						a	b						
140	RE 14016	140	175	160	16	3	1.6	1	151	167	25.9	50.1	1
	RE 14025		200	172	25	3.5	2	1.5	154	186	74.8	121	2.96
150	RE 15013	150	180	166	13	2.5	1.6	0.6	158	173	27	53.5	0.68
	RE 15025		210	182	25	3.5	2	1.5	164	196	76.8	128	3.16
	RE 15030		230	192	30	4.5	3	1.5	173	210	100	156	5.3
160	RE 16025	160	220	192	25	3.5	2	1.5	174	206	81.7	135	3.14
170	RE 17020	170	220	196.1	20	3.5	1.6	1.5	187	204	29	62.1	2.21
180	RE 18025	180	240	210	25	3.5	2	1.5	195	225	84	143	3.44
190	RE 19025	190	240	219	25	3.5	1.6	1	207	229	41.7	82.9	2.99
	RE 20025		260	230	25	3.5	2	2	215	245	84.2	157	4
200	RE 20030	200	280	240	30	4.5	3	2	221	258	114	200	6.7
	RE 20035		295	247.7	35	5	3	2	225	270	151	252	9.6
	RE 22025		220	280	250.1	25	3.5	2	2	235	265	92.3	171
240	RE 24025	240	300	272.5	25	3.5	2	2.5	258	284	68.3	145	4.5
	RE 25025		310	280.9	25	3.5	2	2.5	268	293	69.3	150	5
250	RE 25030	250	330	287.5	30	4.5	3	2.5	269	306	126	244	8.1
	RE 25040		355	300.7	40	6	3.5	2.5	275	326	195	348	14.8
	RE 30025		360	332	25	3.5	2	2.5	319	344	75.5	178	5.9
300	RE 30035	300	395	345	35	5	3	2.5	322	368	183	367	13.4
	RE 30040		405	351.6	40	6	3.5	2.5	326	377	212	409	17.2
	RE 35020		350	400	376.6	20	3.5	1.6	2.5	365	386	54.1	143

Note1) The model number of a type with seals attached is RE...UU.

If a certain level of accuracy is required, this model is used for outer ring rotation.

Note2) (a) and (b) dimensions of the greasing hole in the detailed diagram are reference values.

## Model number coding

**RE8016 UU CC0 P4**

Model number

Accuracy symbol (\*2)

Radial clearance symbol (\*1)

Seal attached on both ends (seal attached on either end: U)

(\*1) See **A18-17**. (\*2) See **A18-13**.

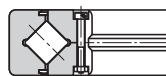
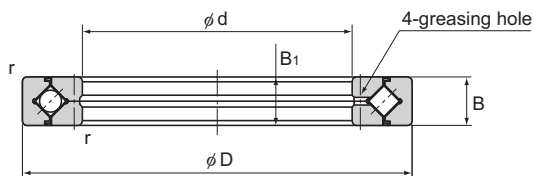

Model RE

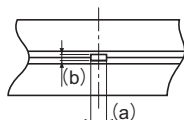
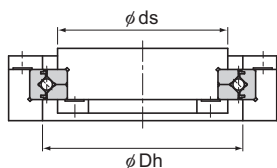

Detail view of the greasing hole

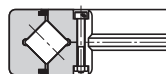

Model RE...UU

Unit: mm

Shaft diameter	Model No.	Main dimensions							Shoulder height		Basic load rating (radial)		Mass
		Inner diameter	Outer diameter	Roller pitch circle diameter	Width	Greasing hole		$r_{min}$	$ds$ (max)	$Dh$ (min)	C	$C_0$	
						B	$B_1$						
400	RE 40035	400	480	440.3	35	5	3	2.5	422	459	156	370	14.5
	RE 40040		510	453.4	40	6	3.5	2.5	428	479	241	531	23.5
450	RE 45025	450	500	476.6	25	3.5	1.6	1	465	486	61.7	182	6.6
500	RE 50025	500	550	526.6	25	3.5	1.6	1	515	536	65.5	201	7.3
	RE 50040		600	548.8	40	6	3	2.5	526	572	239	607	26
	RE 50050		625	561.6	50	6	3.5	2.5	536	587	267	653	41.7
600	RE 60040	600	700	650	40	6	3	3	627	673	264	721	29

Note1) The model number of a type with seals attached is RE...UU.

If a certain level of accuracy is required, this model is used for outer ring rotation.

Note2) (a) and (b) dimensions of the greasing hole in the detailed diagram are reference values.

**Model number coding**

**RE50025 UU CC0 P6**

Model number

Accuracy symbol (\*2)

Radial clearance symbol (\*1)

Seal attached on both ends (seal attached on either end: U)

(\*1) See **A18-17**. (\*2) See **A18-13**.

# USP-Grade Models RB and RE

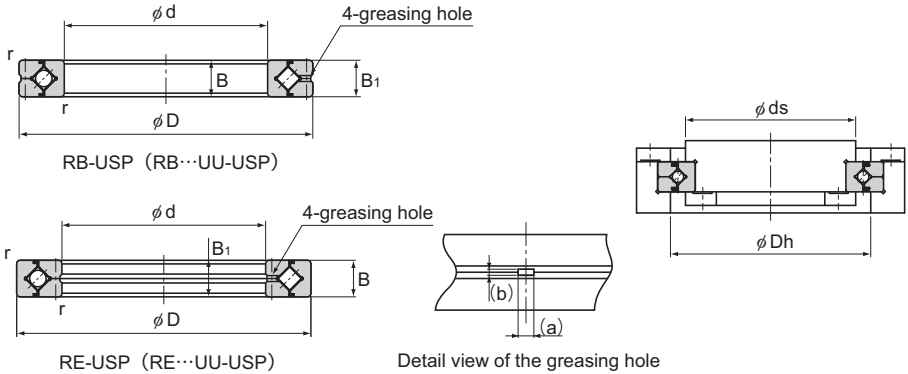

Unit: mm

Model No.	Main dimensions							Shoulder height		Basic load rating (radial)		Mass	
	Inner diameter d	Outer diameter D	Roller pitch circle diameter dp		Width B B <sub>1</sub>	Greasing hole		r <sub>min</sub>	ds (max)	Dh (min)	C kN	C <sub>0</sub> kN	kg
			RB	RE		a	b						
RB 10020USP RE 10020USP	100	150	123	127	20	3.5	1.6	1	113	133	33.1	50.9	1.45
RB 12025USP RE 12025USP	120	180	148.7	152	25	3.5	2	1.5	133	164	66.9	100	2.62
RB 15025USP RE 15025USP	150	210	178	182	25				164	194	76.8	128	3.16
RB 20030USP RE 20030USP	200	280	240	240	30	4.5	3	2	221	258	114	200	6.7
RB 25030USP RE 25030USP	250	330	287.5	287.5	30				269	306	126	244	8.1
RB 30035USP RE 30035USP	300	395	345	345	35	5	3	2.5	322	368	183	367	13.4
RB 40040USP RE 40040USP	400	510	453.4	453.4	40	6	3.5		428	479	241	531	23.5
RB 50040USP RE 50040USP	500	600	548.8	548.8	40	6	3	2.5	526	572	239	607	26
RB 60040USP RE 60040USP	600	700	650	650	40				3	627	673	264	721

Note1) The model number of a type with seals attached is RB...UU-USP or RE...UU-USP.

If a certain level of rotational accuracy is required for the inner ring, select model RB; if a certain level of rotational accuracy is required for the outer ring, select model RE.

Note2) (a) and (b) dimensions of the greasing hole in the detailed diagram are reference values.

## Model number coding

**RB50040 UU CC0 USP**

Model number

Accuracy symbol (Ultra precision grade)

Radial clearance symbol (\*1)

Seal attached on both ends (seal attached on either end: U)

(\*1) See **A18-17**.

# Model RA (Separable Outer Ring Type)

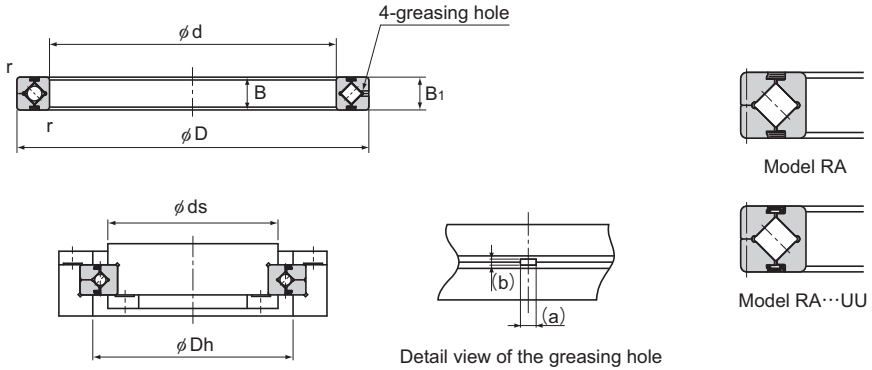

Unit: mm

Shaft diameter	Model No.	Main dimensions							Shoulder height		Basic load rating (radial)		Mass kg
		Inner diameter d	Outer diameter D	Roller pitch circle diameter dp	Width B B <sub>1</sub>	Greasing hole		r <sub>min</sub>	ds (max)	Dh (min)	C kN	C <sub>0</sub> kN	
						a	b						
50	RA 5008	50	66	57	8	2	0.8	0.5	53.5	60.5	5.1	7.19	0.08
60	RA 6008	60	76	67	8	2	0.8	0.5	63.5	70.5	5.68	8.68	0.09
70	RA 7008	70	86	77	8	2	0.8	0.5	73.5	80.5	5.98	9.8	0.1
80	RA 8008	80	96	87	8	2	0.8	0.5	83.5	90.5	6.37	11.3	0.11
90	RA 9008	90	106	97	8	2	0.8	0.5	93.5	100.5	6.76	12.4	0.12
100	RA 10008	100	116	107	8	2	0.8	0.5	103.5	110.5	7.15	13.9	0.14
110	RA 11008	110	126	117	8	2	0.8	0.5	113.5	120.5	7.45	15	0.15
120	RA 12008	120	136	127	8	2	0.8	0.5	123.5	130.5	7.84	16.5	0.17
130	RA 13008	130	146	137	8	2	0.8	0.5	133.5	140.5	7.94	17.6	0.18
140	RA 14008	140	156	147	8	2	0.8	0.5	143.5	150.5	8.33	19.1	0.19
150	RA 15008	150	166	157	8	2	0.8	0.5	153.5	160.5	8.82	20.6	0.2
160	RA 16013	160	186	172	13	2.5	1.6	0.8	165	179	23.3	44.9	0.59
170	RA 17013	170	196	182	13	2.5	1.6	0.8	175	189	23.5	46.5	0.64
180	RA 18013	180	206	192	13	2.5	1.6	0.8	185	199	24.5	49.8	0.68
190	RA 19013	190	216	202	13	2.5	1.6	0.8	195	209	24.9	51.5	0.69
200	RA 20013	200	226	212	13	2.5	1.6	0.8	205	219	25.8	54.7	0.71

Note1) The model number of a type with seals attached is RA···UU.  
If a certain level of accuracy is required, this model is used for inner ring rotation.  
Note2) (a) and (b) dimensions of the greasing hole in the detailed diagram are reference values.

### Model number coding

**RA7008 UU CC0**

Model number

Radial clearance symbol (\*1)

Seal attached on both ends (seal attached on either end: U)

(\*1) See **A18-17**.

# Model RA-C (Single-Split Type)

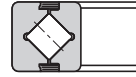
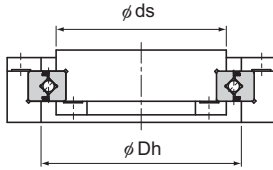
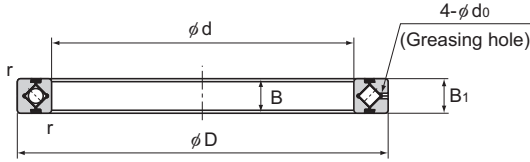

Model RA...C

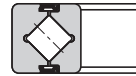

Model RA...CUU

Unit: mm

Shaft diameter	Model No.	Main dimensions						Shoulder height		Basic load rating (radial)		Mass
		Inner diameter d	Outer diameter D	Roller pitch circle diameter dp	Width B B <sub>1</sub>	Greasing hole d <sub>o</sub>	r <sub>min</sub>	ds (max)	Dh (min)	C kN	C <sub>0</sub> kN	
50	RA 5008C	50	66	57	8	1.5	0.5	53.5	60.5	5.1	7.19	0.08
60	RA 6008C	60	76	67	8	1.5	0.5	63.5	70.5	5.68	8.68	0.09
70	RA 7008C	70	86	77	8	1.5	0.5	73.5	80.5	5.98	9.8	0.1
80	RA 8008C	80	96	87	8	1.5	0.5	83.5	90.5	6.37	11.3	0.11
90	RA 9008C	90	106	97	8	1.5	0.5	93.5	100.5	6.76	12.4	0.12
100	RA 10008C	100	116	107	8	1.5	0.5	103.5	110.5	7.15	13.9	0.14
110	RA 11008C	110	126	117	8	1.5	0.5	113.5	120.5	7.45	15	0.15
120	RA 12008C	120	136	127	8	1.5	0.5	123.5	130.5	7.84	16.5	0.17
130	RA 13008C	130	146	137	8	1.5	0.5	133.5	140.5	7.94	17.6	0.18
140	RA 14008C	140	156	147	8	1.5	0.5	143.5	150.5	8.33	19.1	0.19
150	RA 15008C	150	166	157	8	1.5	0.5	153.5	160.5	8.82	20.6	0.2
160	RA 16013C	160	186	172	13	2	0.8	165	179	23.3	44.9	0.59
170	RA 17013C	170	196	182	13	2	0.8	175	189	23.5	46.5	0.64
180	RA 18013C	180	206	192	13	2	0.8	185	199	24.5	49.8	0.68
190	RA 19013C	190	216	202	13	2	0.8	195	209	24.9	51.5	0.69
200	RA 20013C	200	226	212	13	2	0.8	205	219	25.8	54.7	0.71

Note) The model number of a type with seals attached is RA...CUU.  
If a certain level of accuracy is required, this model is used for inner ring rotation.

## Model number coding

**RA6008C UU C0**

Model number

Radial clearance symbol (\*1)

Seal attached on both ends (seal attached on either end: U)

(\*1) See **A18-17**.

## Fit

### [Fitting of Models RU]

Fitting for model RU is typically not required. However, for fitting requiring positioning accuracy, h7 and H7 are recommended.

### [Fitting of Models RB, RE and RA]

For the fitting of models RB, RE and RA, we recommend using the combinations indicated in Table1.

Table1 Fitting of Models RB, RE and RA

Radial clearance	Service condition		Shaft	Housing
CC0	Inner ring rotational load	Normal load	g5	H7
		Large impact and moment		
	Outer ring rotational load	Normal load		
		Large impact and moment		
C0	Inner ring rotational load	Normal load	h5	H7
		Large impact and moment		
	Outer ring rotational load	Normal load	g5	Js7
		Large impact and moment		
C1	Inner ring rotational load	Normal load	j5	H7
		Large impact and moment	k5	Js7
	Outer ring rotational load	Normal load	g6	Js7
		Large impact and moment	h5	K7

Note) For the fitting for clearance CC0, avoid interference because it will cause an excessive preload. In addition, if higher rigidity is required, we recommend measuring the inner and outer diameters of the bearing and applying a slight interference fit to match the diameters.

### [Fitting of the USP-grade]

For the fitting of the USP-grade series of models RB and RE, we recommend using the combinations indicated in Table2.

Table2 Fitting of the USP-grade

Radial clearance	Condition	Shaft	Housing
CC0	Inner ring rotational load	h5	J7
	Outer ring rotational load	g5	Js7
C0	Inner ring rotational load	j5	J7
	Outer ring rotational load	g5	K7

Note) It is recommended that you measure the inside and outside diameters of the bearing and provide a slight interference fit for those measurements.

### [Fitting of Model RA-C]

Since model RA-C is thin and its outer ring is split in one position, it is considerably affected by fit. We recommend measuring the inner and outer diameters of the bearing and applying a slight interference fit to match the diameters.

# Designing the Housing and the Presser Flange

Since the Cross-Roller Ring is a compact, thin device, special consideration must be given to the rigidity of the housing and the presser flange.

With types having a separable outer ring, insufficiency in the strength of the housing, pressure flange or the presser bolt will result in the inability to evenly hold the inner or outer ring, or the deformation of the Cross-Roller Ring when a moment load is applied. Consequently, the contact area of the rollers will become uneven, causing performance to significantly deteriorate.

Fig.2 shows examples of installing the Cross-Roller Ring.

## [Housing]

When designing the thickness of the housing, make sure it is at least 60% of the sectional height of the cross roller ring as a general guide.

$$\text{Housing thickness } T = \frac{D-d}{2} \times 0.6 \text{ or greater}$$

(D: outer diameter of the outer ring; d: inner diameter of the inner ring)

If greater stiffness is desired, both the thickness of the housing and the fitting tolerance must be considered. Please contact THK when making such considerations.

## ● [Shoulder Design]

When designing the shoulder, ensure that the shaft shoulder diameter ( $\phi ds$ ) is inside the raceway, and that the housing shoulder height ( $\phi Dh$ ) are outside the raceway.

If the shoulder diameter approaches the raceway, then an uneven load may apply, resulting in a faulty rotation.

For the shoulder dimensions, see the corresponding specification table.

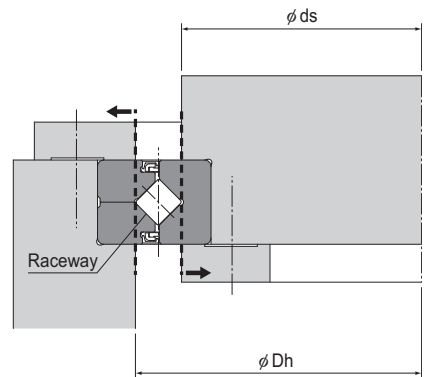

## ● Tapped Hole for Ring Removal

By including tapped holes for inner and outer ring removal (Fig.1), it becomes possible to remove the rings without damaging the cross roller ring. Avoid pushing the inner ring when removing the outer ring, or vice versa.

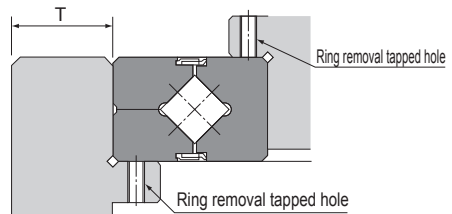
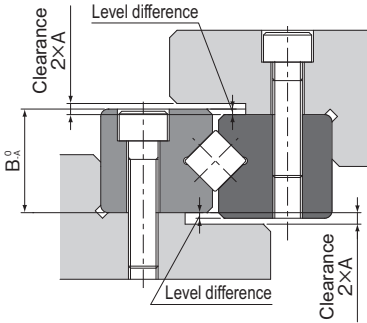

Fig.1



● **Level difference between the inner and outer rings**

Since there is a level difference between the inner and outer rings of the Cross-Roller Ring, it is necessary to provide a clearance in the housing. The clearance must be at least twice the tolerance A of the width dimension. For the tolerance A of the width dimension, see the accuracy standard (see pages **A18-12** to **A18-15**).



Model No.	Width dimension
RB	$B_{1-A}^0$
RE	
RA	$B_{-A}^0 = B_{1-A}^0$
RA-C	
RU	$B_{-A}^0$

Note) For models RB and RE, refer to the tolerance of the width dimension of B1.

[Example of Assembly]

Fig.2 and Fig.3 show examples of installing the Cross-Roller Ring.

Example of Assembling Model RE

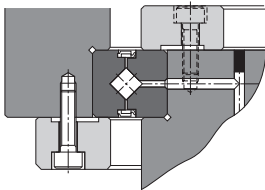

a. Outer ring rotating in the swiveling unit

A heavy body part is mounted after the inner and outer rings are secured.

Example 1 of assembling model RB

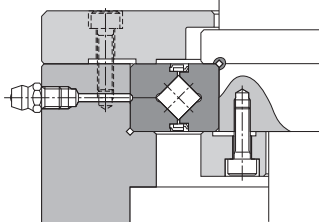

b. Inner ring rotating in the swiveling unit (with seals attached)

Example 2 of assembling model RB

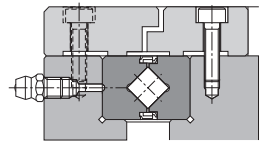

c. Inner and outer rings secured in the same direction in the swiveling unit (with seals attached)

Fig.2 Examples of Assembling Models RE and RB

Example 1 of assembling model RU

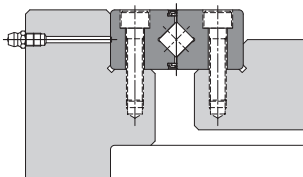

d. Inner and outer rings secured in the same direction in the swiveling unit (with seals attached)

Example 2 of assembling model RU

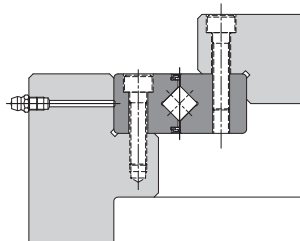

e. Inner and outer rings secured in the same direction in the swiveling unit (with seals attached)

Fig.3 Examples of Assembling Model RU

### [Presser Flange and Presser Bolt]

When determining the thickness of the presser flange (F) or the clearance of the flange section (S), refer to the dimensions indicated below as a guide.

As for the number of the presser bolts, the greater the number of the bolts, the more stable the system becomes. As a guide, however, it is normally appropriate to use the number of bolts indicated in Table3 and equidistantly arrange them.

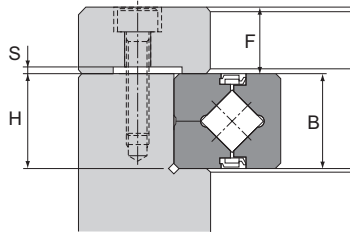

$$F = B \times 0.5 \text{ to } B \times 1.2$$

$$H = B_{0,1}^0$$

$$S = 0.5 \text{ mm}$$

Even if the shaft and the housing are made of light alloy, it is recommendable to select a steel-based material for the presser flange. When assembling model RU, use the mounting holes or tapped holes built on the inner and outer rings (model RU does not require a presser flange).

When tightening the presser bolts, firmly secure them using a torque wrench or the like so that they will not loosen. Table4 shows tightening torques for the housing and presser flanges made of typical steel materials with medium hardness.

Table3 Number of Presser Bolts and Bolt Sizes

Unit: mm

Outer diameter of the outer ring (D)		No. of bolts	Bolt size (reference value)
Above	Or less		
—	100	8 or more	M3 to M5
100	200	12 or more	M4 to M8
200	500	16 or more	M5 to M12
500	—	24 or more	M12 or thicker

Table4 Bolt Tightening Torque

Unit: N·m

Screw model No.	Tightening torque	Screw model No.	Tightening torque
M3	2	M10	70
M4	4	M12	120
M5	9	M16	200
M6	14	M20	390
M8	30	M22	530

### [Surface Treatment]

- (1) If the Cross-Roller Ring requires surface treatment, contact THK.
- (2) For the details of the surface treatment, see **B0-20** on the general catalog.
- (3) Note that in the case of standard model RU and special models, it is difficult to provide surface treatment to mounting holes built on the inner and outer rings, greasing holes, etc., and a treated film may not be formed on these areas.
- (4) Product accuracy (dimensional accuracy, rotational accuracy) is only guaranteed prior to surface treatment.

## Model Number Coding

Model number configurations differ depending on the model features. Refer to the corresponding sample model number configuration.

### [Cross roller rings with integrated inner and outer rings.]

#### ● Model RU

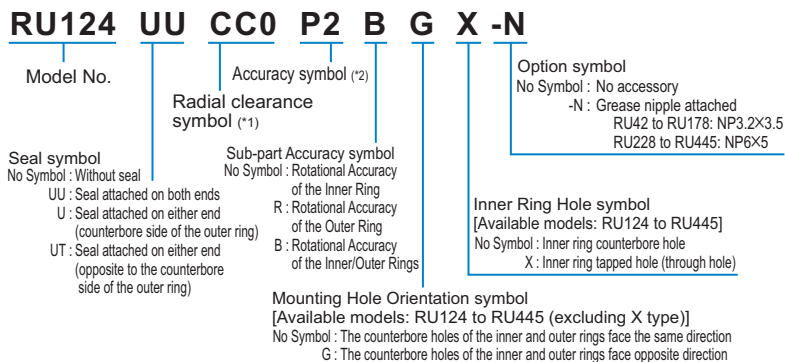

(\*1) See [A18-17](#). (\*2) See [A18-12](#) to [A18-16](#).

### [Cross Roller Ring]

#### ● Models RB, RE, RA and RA-C

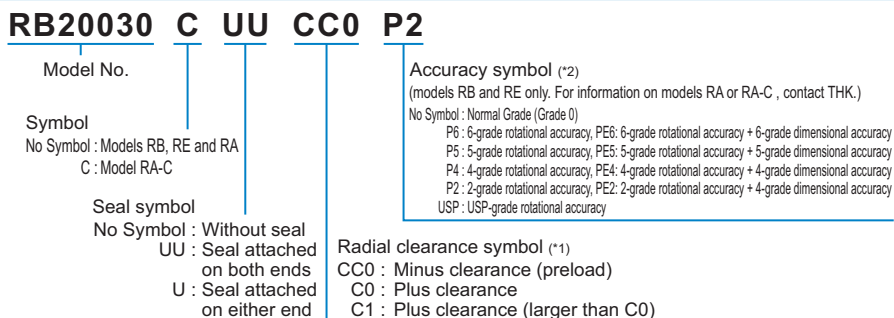

(\*1) See [A18-17](#). (\*2) See [A18-12](#) to [A18-16](#).

## [Handling]

- (1) Please use at least two people to move any product weighing 20 kg or more, or use a dolly or another conveyance. Doing so may cause injury or damage.
- (2) The inner and outer rings, which are comprised of two parts, are held together with a special rivet or screws, so install as is. Incorrect installation of the spacer retainer will greatly affect rotational performance, do not disassemble the Cross Roller Ring.
- (3) Take care not to drop or strike the Cross Roller Ring. Doing so may cause injury or damage. Giving an impact to it could also cause damage to its function even if the product looks intact.
- (4) When handling the product, wear protective gloves, safety shoes, etc., as necessary to ensure safety.

## [Precautions on Use]

- (1) Prevent foreign material, such as cutting chips or coolant, from entering the product. Failure to do so may cause damage.
- (2) If the product is used in an environment where cutting chips, coolant, corrosive solvents, water, etc., may enter the product, use bellows, covers, etc., to prevent them from entering the product.
- (3) Do not use the product at temperature of 80°C or higher. Exposure to higher temperatures may cause the resin/rubber parts to deform/be damaged.
- (4) If foreign material such as cutting chips adheres to the product, replenish the lubricant after cleaning the product.
- (5) Slight rocking can inhibit the formation of a film of oil between the rolling surface and the area of contact, resulting in fretting. THK recommends periodically rotating the cross roller ring several times to help ensure that a film forms on the surfaces and rolling elements.
- (6) Do not use undue force when fitting parts (pin, key, etc.) to the product. This may generate permanent deformation on the raceway, leading to loss of functionality.
- (7) The matching mark of the inner or outer ring may be slightly misaligned when delivered. In that case, loosen the bolts that secure the inner or outer ring, and correct the alignment using a plastic hammer or the like, before installing it to the housing. (Let the securing rivets follow the housing.)
- (8) When installing the Cross-Roller Ring, insert the ring by hammering the ring that is to be fixed (i.e. hammer the inner ring if the inner ring is to be fixed, or hammer the outer ring if the outer ring is to be fixed). Hammering the ring on the wrong side may cause damage.
- (9) Insufficient rigidity or accuracy of mounting members causes the bearing load to concentrate on one point, and the bearing performance will drop significantly. Accordingly, give sufficient consideration to the rigidity/accuracy of the housing and base and strength of the fixing bolts.
- (10) When installing or removing the Cross Roller Ring, do not apply force to the fixing rivets or the bolts.
- (11) When mounting the presser flange, take into account the dimensional tolerances of the parts so that the flange firmly holds the inner and outer rings from the side.

**[Lubrication]**

- (1) Do not mix different lubricants. Mixing greases using the same type of thickening agent may still cause adverse interaction between the two greases if they use different additives, etc.
- (2) When using the product in locations exposed to constant vibrations or in special environments such as clean rooms, vacuum and low/high temperature, use the grease appropriate for the specification/environment.
- (3) The consistency of grease changes according to the temperature. Take note that the torque of the Cross Roller Ring also changes as the consistency of grease changes.
- (4) Since each Cross Roller Ring unit contains high-quality lithium soap group grease No. 2, initial greasing is not needed. However, the product requires regular lubrication since it has a smaller internal space than ordinary roller bearings and because the rollers need frequent lubrication due to their rolling contact structure.

To replenish grease, it is necessary to access greasing holes that lead to the oil grooves formed on the inner and outer rings. As for the lubrication interval, normally replenish the same type of grease so that it is distributed throughout the interior at least every three to six months. Set the final lubrication interval/amount based on the actual machine.

When the bearing is filled up with grease, the initial rotational torque temporarily increases due to grease resistance. However, surplus grease will run off of the seals and the torque will return to the normal level in a short period. The thin type does not have an oil groove. Secure an oil groove in the inner diameter side of the housing for lubrication.

**[Storage]**

When storing the Cross Roller Ring, enclose it in a package designated by THK and store it in a room in a horizontal orientation while avoiding high temperature, low temperature and high humidity. After the product has been in storage for an extended period of time, lubricant inside may have deteriorated, so add new lubricant before use.

**[Disposal]**

Dispose of the product properly as industrial waste.





# Cross-Roller Ring

THK General Catalog

## B Support Book

<b>Features and Types</b> .....	A18-2
Features of the Cross-Roller Ring .....	A18-2
• Structure and Features .....	A18-2
Types of the Cross-Roller Ring .....	A18-5
• Types and Features .....	A18-5
<b>Point of Selection</b> .....	A18-7
Selecting a Cross-Roller Ring .....	A18-7
Nominal Life .....	A18-8
Static Safety Factor .....	A18-10
• Example of calculation (1): Horizontal Installation ..	A18-11
• Example of calculation (2): Vertical Installation .....	A18-12
Static Permissible Moment .....	A18-13
• Example of Calculating a Static Permissible Moment ..	A18-13
Static Permissible Axial Load .....	A18-13
• Example of Calculating a Static Permissible Axial Load ...	A18-13
<b>Mounting Procedure</b> .....	A18-14
Procedure for Assembly .....	A18-14
<b>Model No.</b> .....	A18-15
• Model Number Coding .....	A18-15
<b>Precautions on Use</b> .....	A18-16

## A Product Descriptions (Separate)

<b>Features and Types</b> .....	A18-2
Features of the Cross-Roller Ring .....	A18-2
• Structure and Features .....	A18-2
Types of the Cross-Roller Ring .....	A18-5
• Types and Features .....	A18-5
<b>Point of Selection</b> .....	A18-7
Selecting a Cross-Roller Ring .....	A18-7
Nominal Life .....	A18-8
Static Safety Factor .....	A18-10
Static Permissible Moment .....	A18-11
Static Permissible Axial Load .....	A18-11
Accuracy Standards .....	A18-12
• Accuracy Standard of the USP-Grade Series ..	A18-16
Radial Clearance .....	A18-17
Moment Rigidity .....	A18-18
<b>Dimensional Drawing, Dimensional Table</b>	
Model RU (Integrated Inner/Outer Ring Type) ..	A18-20
Model RB (Separable Outer Ring Type) ..	A18-22
Model RE (Two-piece Inner Ring Type) ..	A18-25
USP-Grade Models RB and RE .....	A18-28
Model RA (Separable Outer Ring Type) ..	A18-29
Model RA-C (Single-Split Type) .....	A18-30
<b>Point of Design</b> .....	A18-31
Fit .....	A18-31
Designing the Housing and the Presser Flange ..	A18-32
<b>Model No.</b> .....	A18-35
• Model Number Coding .....	A18-35
<b>Precautions on Use</b> .....	A18-36

## Features of the Cross-Roller Ring

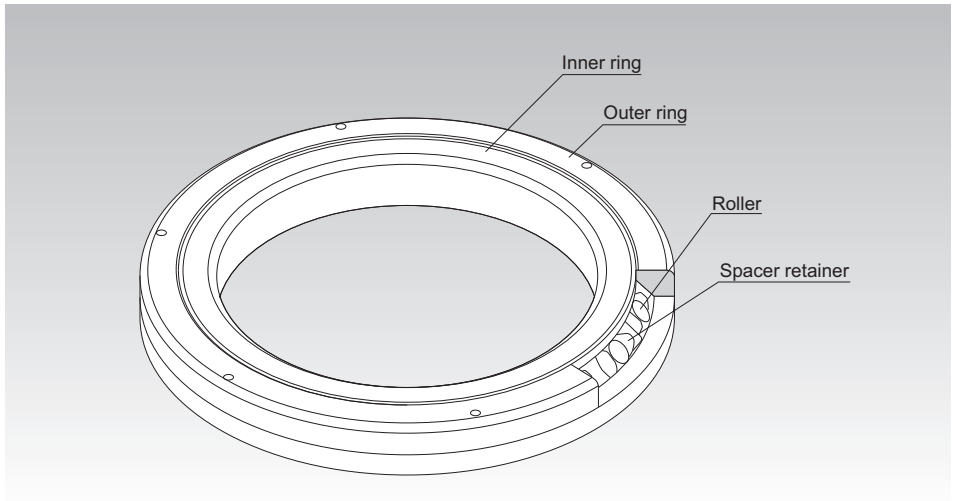

Fig.1 Structure of Cross Roller-Ring Model RB

### Structure and Features

With the Cross-Roller Ring, cylindrical rollers are arranged with each roller perpendicular to the adjacent roller, in a  $90^\circ$  V groove, separated from each other by a spacer retainer. This design allows just one bearing to receive loads in all directions including radial, axial and moment loads.

Since the Cross-Roller Ring achieves high rigidity despite the minimum possible dimensions of the inner and outer rings, it is optimal for applications such as joints and swiveling units of industrial robots, swiveling tables of machining centers, rotary units of manipulators, precision rotary tables, medical equipment, measuring instruments and IC manufacturing machines.

#### [High Rotation Accuracy]

The spacer retainer fitting among cross-arrayed rollers prevents rollers from skewing and the rotational torque from increasing due to friction between rollers. Unlike conventional types using steel sheet retainers, the Cross-Roller Ring does not cause unilateral contact of roller or seize. Thus, even under a preload, the Cross-Roller Ring provides stable rotation.

Since the inner and outer rings are designed to be separable, the preload can be adjusted, and this feature enables accurate rotation.



**[Easy Handling]**

The inner and outer rings, which are separable, are secured to the Cross-Roller Ring body after being installed with rollers and spacer retainers in order to prevent the rings from separating from each other. Thus, it is easy to handle the rings when installing the Cross-Roller Ring.

**[Skewing Prevention]**

The spacer retainer keeps rollers in their proper position, thereby preventing them from skewing (tilted rollers). This eliminates friction between rollers, and therefore secures a stable rotational torque.

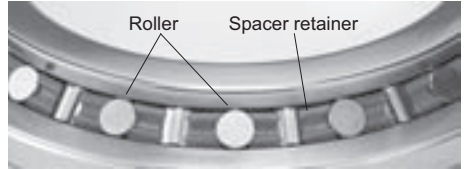

**[Increased Rigidity (Three to Four Times Greater than the Conventional Type)]**

Unlike the thin angular ball bearings installed in double rows, the cross array of rollers allows a single Cross-Roller Ring unit to receive loads in all directions, increasing the rigidity to three to four times greater than the conventional type.

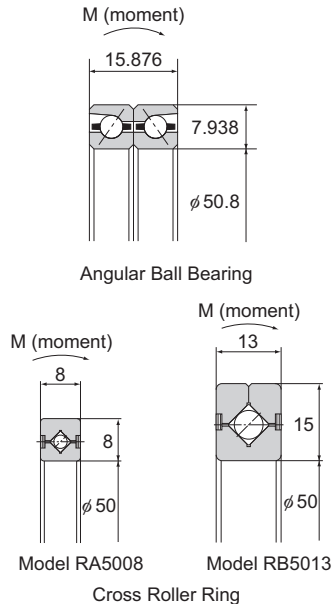
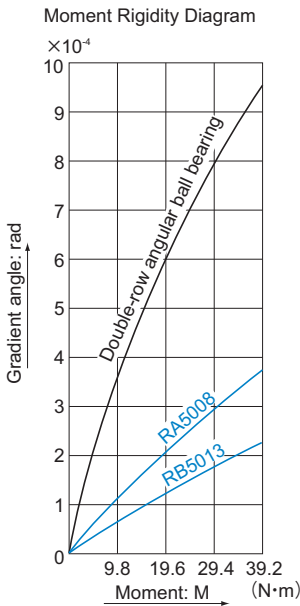

**[Large Load Capacity]**

(1) Compared with conventional steel sheet retainers, the spacer retainer allows a longer effective contact length of each roller, thus significantly increasing the load capacity.

The spacer retainer guides rollers by supporting them over the entire length of each roller, whereas the conventional type of retainer supports them only at a point at the center of each roller. Such one-point contact cannot sufficiently prevent skewing.

Roller contact length

$$l_1 > l_2$$

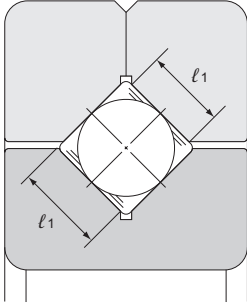

With a spacer retainer

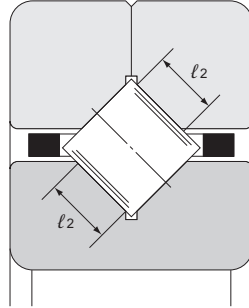

With a steel sheet retainer (conventional type)

(2) In conventional types, the loaded areas are asymmetrical between the outer ring and the inner ring sides around the roller longitudinal axis. The greater the applied load is, the greater the moment becomes, leading end-face contact to occur. This causes frictional resistance, which hinders smooth rotation and quickens wear.

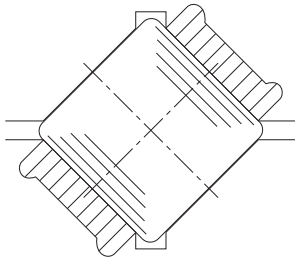

Loaded areas symmetrical  
With a spacer retainer

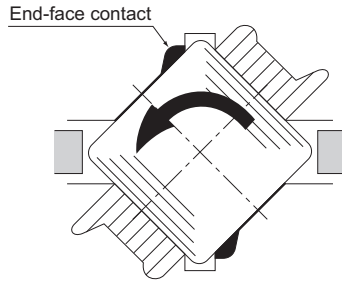

Loaded areas asymmetrical  
With a steel sheet retainer (conventional type)

# Types of the Cross-Roller Ring

## Types and Features

### Model RU (Integrated Inner/Outer Ring Type)

Specification Table⇒ **A** 18-20

The integrated design of the unit's inner and outer rings, with mounting holes on both rings, eliminates the need for a special flange or housing and enables easy installation. Mounting has virtually no effect on performance, which ensures stable, accurate rotation and torque. Can be used for both outer and inner ring rotation.

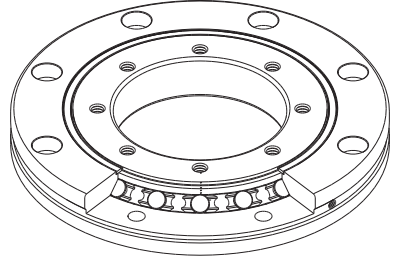

Model RU

### Model RB (Separable Outer Ring Type for Inner Ring Rotation)

Specification Table⇒ **A** 18-22

Cross-Roller Ring basic type, with a separable outer ring, and an inner ring integrated with the main body. It is used in locations where the rotational accuracy of the inner ring is required. It is used, for example, in the swivel portions of index tables of machine tools.

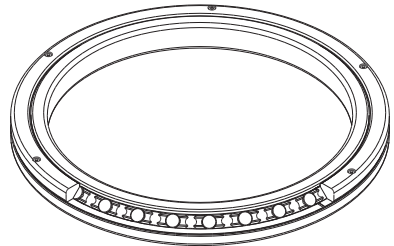

Model RB

### Model RE (Two-piece Inner Ring Type for Outer Ring Rotation)

Specification Table⇒ **A** 18-25

Main dimensions are the same as model RB. This model is used in locations where the rotational accuracy of the outer ring is required.

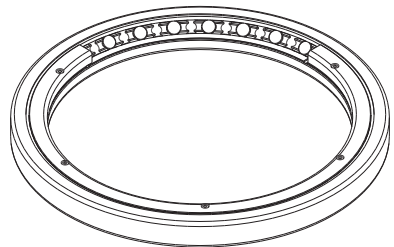

Model RE

## USP-Grade Series of Models RB and RE

Specification Table⇒ **A18-28**

The rotation accuracy of the USP-Grade Series achieves the ultra precision grade that surpasses the world's highest accuracy standards such as JIS Class 2, ISO Class 2, DIN P2 and AFBMA ABCE9.

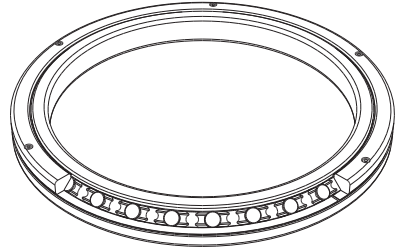

## Model RA (Separable Outer Ring Type for Inner Ring Rotation)

Specification Table⇒ **A18-29**

A compact type similar to model RB with the thinnest possible inner and outer rings. Optimal for locations requiring a light-weight and compact design such as the swivel portions of robots and manipulators.

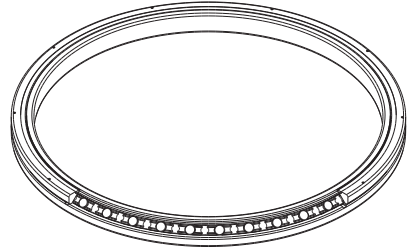

Model RA

## Model RA-C (Single-Split Type)

Specification Table⇒ **A18-30**

The main dimensions are the same as that of model RA. Owing to its Single-split Outer Ring structure with a highly rigid outer ring, this model can be used for outer ring rotation.

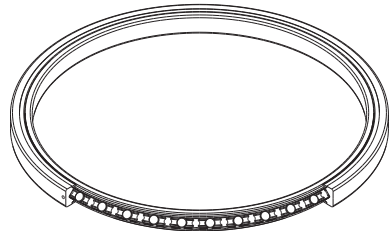

Model RA-C

## Selecting a Cross-Roller Ring

The following diagram shows a typical procedure for selecting a Cross-Roller Ring.

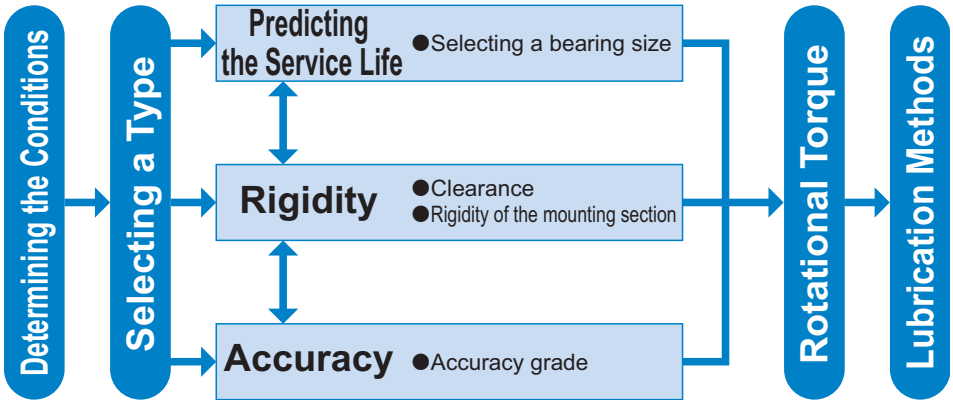

- Inner ring rotating……Model RB
- Outer ring rotating……Model RE
- Mounting space……Models RA-C and RA

# Nominal Life

## [Nominal Life]

The service life of the Cross-Roller Ring is obtained from the following equation.

$$L = \left( \frac{f_T \cdot C}{f_w \cdot P_c} \right)^{\frac{10}{3}} \times 10^6$$

**L** : Nominal life  
 (The total number of revolutions that 90% of a group of identical Cross-Roller Ring units independently operating under the same conditions can achieve without showing flaking from rolling fatigue)

**C** : Basic dynamic load rating\* (N)

**P<sub>c</sub>** : Dynamic equivalent radial load (N)  
 (see **B18-9**)

**f<sub>T</sub>** : Temperature factor (see Fig.1)

**f<sub>w</sub>** : Load factor (see Table1)

\* The basic dynamic load rating (C) refers to a radial load of unvarying direction and magnitude for which the rated life (L) is 1 million revolutions, based on a group of identical Cross-Roller Rings operating independently under identical conditions. Basic dynamic load ratings are shown in the dimensional tables.

\* Rated life is calculated according to load and presumes optimal mounting conditions and adequate lubrication. Usage involving back-and-forth motion or low-speed operation may affect lubrication requirements. Please consult THK for assistance in calculating service life for usage involving back-and-forth motion or low-speed operation.

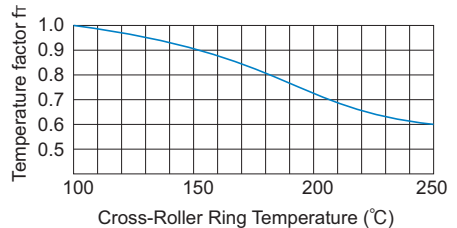

Note) The normal service temperature is 80°C or below. If the product is to be used at a higher temperature, contact THK.

## [f<sub>w</sub>:Load Factor]

Machines that perform rotary movements are often subjected to vibration and impact during operation. It is difficult to accurately identify the cause of vibration from a motor, gears, or other drive components, or of impact arising from frequent starts and stops.

In the event of excessive vibration or impact, divide the basic dynamic load rating (C) by the corresponding load factor, using the empirically obtained figures in Table1 as guidelines.

Table1 Load Factor (f<sub>w</sub>)

Service condition	f <sub>w</sub>
Smooth motion without impact	1 to 1.2
Normal motion	1.2 to 1.5
Excessive vibration or impact	1.5 to 3

[Calculating the Service Life Time]

● For Rotary Motion

$$L_h = \frac{L}{N \times 60}$$

$L_h$  : Service life time (h)  
 $N$  : Rotation speed per minute ( $\text{min}^{-1}$ )

● For Oscillatory Motion

$$L_h = \frac{360 \times L}{2 \times \theta \times n_r \times 60}$$

$L_h$  : Service life time (h)  
 $\theta$  : Rocking angle (deg.)  
 (\* see figure at right)  
 $n_r$  : Number of reciprocations per minute ( $\text{min}^{-1}$ )

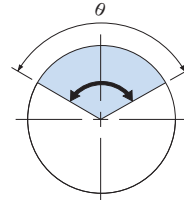

\* Rocking angle: If  $\theta$  is too small, this will hinder the formation of an oil film on the contact surfaces between the race and the roller and may cause fretting. If the product will be used in these conditions, contact THK.

[Dynamic Equivalent Radial Load  $P_c$ ]

The dynamic equivalent radial load of the Cross-Roller Ring is obtained from the following equation.

$$P_c = X \cdot \left( F_r + \frac{2M}{dp} \right) + Y \cdot F_a$$

$P_c$  : Dynamic equivalent radial load (N)  
 $F_r$  : Radial load (N)  
 $F_a$  : Axial load (N)  
 $M$  : Moment (N-mm)  
 $X$  : Dynamic radial factor (see Table2)  
 $Y$  : Dynamic axial factor (see Table2)  
 $dp$  : Roller pitch circle diameter (mm)

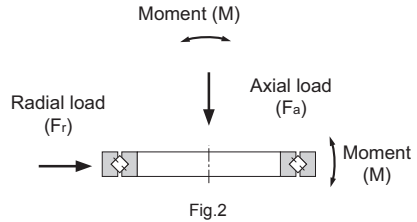

Fig.2

Table2 Dynamic Radial Factor and Dynamic Axial Factor

Classification	X	Y
$\frac{F_a}{F_r + 2M/dp} \leq 1.5$	1	0.45
$\frac{F_a}{F_r + 2M/dp} > 1.5$	0.67	0.67

- If  $F_r = 0\text{N}$  and  $M = 0\text{ N-mm}$ , perform calculation while assuming that  $X = 0.67$  and  $Y = 0.67$ .
- For service life calculation with a preload taken into account, contact THK.

# Static Safety Factor

The basic static load rating  $C_0$  refers to the static load with constant direction and magnitude, under which the calculated contact stress in the center of the contact area between the roller and the raceway under the maximum load is 4000 MPa. (If the contact stress exceeds this level, it will affect the rotation.) This value is indicated as “ $C_0$ ” in the specification tables. When a load is statically or dynamically applied, it is necessary to consider the static safety factor as shown below.

$$\frac{C_0}{P_0} = f_s$$

- $f_s$  : Static safety factor (see Table3)  
 $C_0$  : Basic static load rating (N)  
 $P_0$  : Static equivalent radial load (N)

Table3 Static Safety Factor ( $f_s$ )

Load conditions	Lower limit of $f_s$
Normal load	1 to 2
Impact load	2 to 3

\* Target minimum values for the static safety factor are shown in the table above. For better service life and other aspects of dynamic performance, THK recommends maintaining a figure of 7 or above.

## [Static Equivalent Radial Load $P_0$ ]

The static equivalent radial load of the Cross-Roller Ring is obtained from the following equation.

$$P_0 = X_0 \cdot \left( F_r + \frac{2M}{dp} \right) + Y_0 \cdot F_a$$

- $P_0$  : Static equivalent radial load (N)  
 $F_r$  : Radial load (N)  
 $F_a$  : Axial load (N)  
 $M$  : Moment (N-mm)  
 $X_0$  : Static radial factor ( $X_0=1$ )  
 $Y_0$  : Static axial factor ( $Y_0=0.44$ )  
 $dp$  : Roller pitch circle diameter (mm)

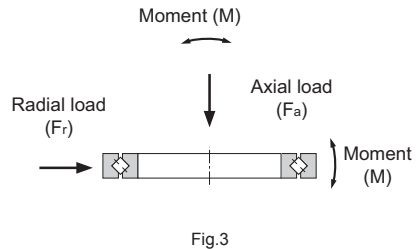



## Example of calculation (1): Horizontal Installation

Calculate the nominal life (L) and the static safety factor ( $f_s$ ) for model RB25025 under the following conditions.

- $m_1 = 100$  kg
- $m_2 = 200$  kg
- $m_3 = 300$  kg
- $D_1 = 300$  mm
- $D_2 = 150$  mm
- $H = 200$  mm
- $C = 69.3$  kN
- $C_0 = 150$  kN
- $dp = 277.5$  mm
- $\omega = 2$  rad/s ( $\omega$ : angular velocity)

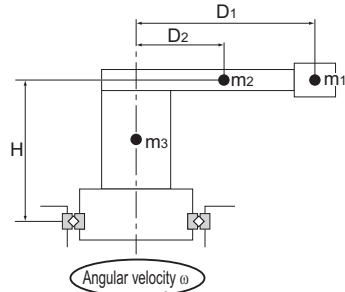

Fig.4

### ● Applied load

$$\begin{aligned} \text{Radial load} \quad : Fr &= m_1 \cdot D_1 \times 10^{-3} \cdot \omega^2 + m_2 \cdot D_2 \times 10^{-3} \cdot \omega^2 \\ &= 100 \cdot 300 \times 10^{-3} \cdot 2^2 + 200 \cdot 150 \times 10^{-3} \cdot 2^2 \\ &= 240 \text{ N} \end{aligned}$$

$$\begin{aligned} \text{Axial load} \quad : Fa &= (m_1 + m_2 + m_3) \times g \\ &= (100 + 200 + 300) \times 9.807 \\ &= 5884.2 \text{ N} \end{aligned}$$

$$\begin{aligned} \text{Moment} \quad : M &= m_1 \cdot g \times D_1 + m_2 \cdot g \times D_2 + (m_1 \cdot D_1 \times 10^{-3} \cdot \omega^2 + m_2 \cdot D_2 \times 10^{-3} \cdot \omega^2) \times H \\ &= 100 \cdot 9.807 \times 300 + 200 \cdot 9.807 \times 150 + \\ &\quad (100 \cdot 300 \times 10^{-3} \cdot 2^2 + 200 \cdot 150 \times 10^{-3} \cdot 2^2) \times 200 \\ &= 636420 \text{ N} \cdot \text{mm} \end{aligned}$$

### ● Nominal life

$$\frac{Fa}{(Fr + 2M/dp)} = \frac{5884.2}{(240 + 2 \times 636420/277.5)} = 1.22 \leq 1.5$$

$$\therefore X = 1, Y = 0.45$$

Therefore, the dynamic equivalent radial load ( $P_c$ ) is obtained as follows.

$$P_c = X \cdot \left( Fr + \frac{2M}{dp} \right) + Y \cdot Fa = 1 \cdot \left( 240 + \frac{2 \times 636420}{277.5} \right) + 0.45 \cdot 5884.2 = 7474.7 \text{ N}$$

If  $f_w = 1.2$ , the nominal life is calculated as follows. Thus, the nominal life (L) is  $9.1 \times 10^8$  revolutions.

$$L = \left\{ \frac{ft \cdot C}{(f_w \cdot P_c)} \right\}^{\frac{10}{3}} \times 10^6 = \left\{ \frac{1 \cdot 69.3 \times 10^3}{(1.2 \cdot 7474.7)} \right\}^{\frac{10}{3}} \times 10^6 = 9.1 \times 10^8 \text{ Rotation}$$

### ● Static safety factor

The static equivalent radial load ( $P_0$ ) is obtained as follows.

$$P_0 = X_0 \cdot \left( Fr + \frac{2M}{dp} \right) + Y_0 \cdot Fa = 1 \cdot \left( 240 + \frac{2 \times 636420}{277.5} \right) + 0.44 \cdot 5884.2 = 7415.8 \text{ N}$$

Using the value of  $P_0$  above, the static safety factor ( $f_s$ ) is calculated to be 20.2.

$$f_s = \frac{C_0}{P_0} = \frac{150 \times 10^3}{7415.8} = 20.2$$

## Example of calculation (2): Vertical Installation

Calculate the nominal life (L) and the static safety factor ( $f_s$ ) for model RB25025 used in the following conditions.

- $m = 300$  kg
- $F = 1500$  N
- $L_1 = 300$  mm
- $L_2 = 150$  mm
- $C = 69.3$  kN
- $C_0 = 150$  kN
- $dp = 277.5$  mm
- $N = 140$  min<sup>-1</sup>

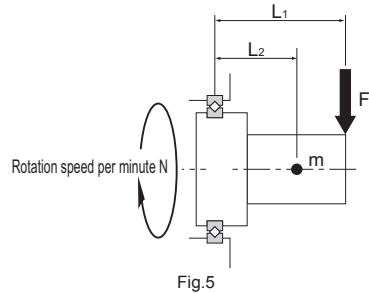

### ● Applied load

Radial load :  $F_r = F + m \cdot g$   
 $= 1500 + 300 \cdot 9.807$   
 $= 4442.1$  N

Axial load :  $F_a = 0$  N

Moment :  $M = F \times L_1 + m \cdot g \times L_2$   
 $= 1500 \times 300 + 300 \cdot 9.807 \times 150$   
 $= 891315$  N·mm

### ● Nominal life

$$\frac{F_a}{(F_r + 2M/dp)} = \frac{0}{(4442.1 + 2 \times 891315/277.5)} = 0 \leq 1.5$$

$\therefore X = 1, Y = 0.45$

Therefore, the dynamic equivalent radial load ( $P_e$ ) is obtained as follows.

$$P_e = X \cdot \left( F_r + \frac{2M}{dp} \right) + Y \cdot F_a = 1 \cdot \left( 4442.1 + \frac{2 \times 891315}{277.5} \right) + 0.45 \cdot 0 = 10866$$
 N

If  $f_w = 1.2$ , the nominal life is calculated as follows. Thus, the nominal life (L) is  $2.6 \times 10^8$  revolutions.

$$L = \left\{ \frac{f_t \cdot C}{(f_w \cdot P_e)} \right\}^{\frac{10}{3}} \times 10^6 = \left\{ \frac{1 \cdot 69.3 \times 10^3}{(1.2 \cdot 10866)} \right\}^{\frac{10}{3}} \times 10^6 = 2.6 \times 10^8$$
 Rotation

### ● Static safety factor

the static equivalent radial load ( $P_0$ ) is obtained as follows.

$$P_0 = X_0 \cdot \left( F_r + \frac{2M}{dp} \right) + Y_0 \cdot F_a = 1 \cdot \left( 4442.1 + \frac{2 \times 891315}{277.5} \right) + 0.44 \cdot 0 = 10866$$
 N

Using the value of  $P_0$  above, the static safety factor ( $f_s$ ) is calculated to be 13.8.

$$f_s = \frac{C_0}{P_0} = \frac{150 \times 10^3}{10866} = 13.8$$

## Static Permissible Moment

The static permissible moment ( $M_0$ ) of the Cross-Roller Ring is obtained from the following equation.

$$M_0 = C_0 \cdot \frac{dp}{2} \times 10^{-3}$$

- $M_0$  : Static Permissible Moment (kN·m)  
 $C_0$  : Basic static load rating (kN)  
 $dp$  : Roller pitch circle diameter (mm)

### Example of Calculating a Static Permissible Moment

Model No. RB25025  
 $C = 69.3$  kN  
 $C_0 = 150$  kN  
 $dp = 277.5$  mm

The static permissible moment is calculated as follows.

$$M_0 = C_0 \cdot \frac{dp}{2} \times 10^{-3} = 150 \cdot \frac{277.5}{2} \times 10^{-3} = 20.8 \text{ kN} \cdot \text{m}$$

## Static Permissible Axial Load

The static permissible axial load ( $F_{a0}$ ) of the Cross-Roller Ring is obtained from the following equation.

$$F_{a0} = \frac{C_0}{Y_0}$$

- $F_{a0}$  : Static permissible axial load (kN)  
 $Y_0$  : Static axial factor ( $Y_0 = 0.44$ )

### Example of Calculating a Static Permissible Axial Load

Model No. RB25025  
 $C = 69.3$  kN  
 $C_0 = 150$  kN

The static permissible axial load ( $F_{a0}$ ) is calculated as follows.

$$F_{a0} = \frac{C_0}{Y_0} = \frac{150}{0.44} = 340.9 \text{ kN}$$

## Procedure for Assembly

When assembling the Cross-Roller Ring, follow the steps below.

### [Preparations before assembly]

- (1) Thoroughly clean the housing and other assembly parts, and make sure there are no burrs.
- (2) Loosen the bolts that prevent separation of the Cross-Roller Ring.
- (3) If the two divided parts of the outer or inner ring are misaligned at the joints, correct the misalignment by gently hitting the ring with a plastic hammer or the like, and then install it. (For a type secured with rivets, install it as-is.)

### [Installing the Cross-Roller Ring into the Housing or onto the Shaft]

Since the cross roller ring has a thin-walled structure, it is easily tilted during insertion. Use a plastic hammer or similar tool to level the cross roller ring by gradually hammering the perimeter while inserting. Carefully hammer until the sound of the ring coming into full contact with the mounting surface can be verified.

Note) When inserting the inner ring, hammer the inner ring. When inserting the outer ring, hammer the outer ring.

### [Assembly directions for RU]

Model RU has insertion holes for installing rollers in the outer ring. (Filler plugs are attached.) Position the mounting direction so that the filler plugs do not overlap with the area under maximum load. (The periphery of the plugged section is slightly recessed, and a fixing pin is driven into its side.)

### [Assembly directions for RA···C]

The outer ring of model RA···C has a slit for installing rollers. Position the mounting direction so that the split section does not overlap with the area under maximum load. (The split section has two small holes on the side marked with the product name.)

### [Attaching the Presser Flange]

- (1) Fit the presser flange to the single piece ring (inner ring on models RB/RA , outer ring on model RE). In case of model RU, fit the presser flange to the rotational axis side.
- (2) Place the presser flange onto the Cross-Roller Ring. Rock the flange several times to match the bolt holes. Also in case of model RU, rock the flange several times to match the bolt holes.
- (3) Insert the presser bolts into the holes. Manually turn the bolts and make sure they do not show skewing caused by misalignment of the holes.
- (4) Fasten the presser bolts in three to four steps from loose to fully fastened by tightening the bolts in a diamond pattern, as shown in Fig.1. When tightening the separated inner or outer ring, reciprocating the single piece outer or inner ring approximately four to five times (about 90°) will correct misalignment between the ring and the body.

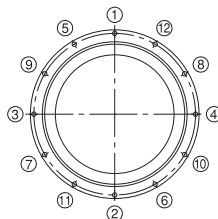

Fig.1 Tightening Sequence

## Model Number Coding

Model number configurations differ depending on the model features. Refer to the corresponding sample model number configuration.

### [Cross roller rings with integrated inner and outer rings.]

#### ● Model RU

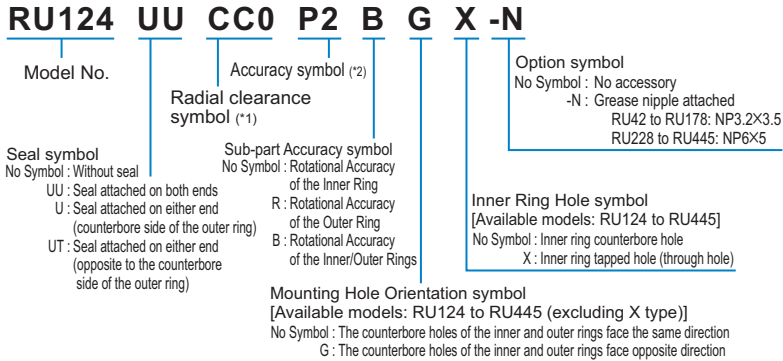

(\*1) See **▣18-17**. (\*2) See **▣18-12** to **▣18-16**.

### [Cross Roller Ring]

#### ● Models RB, RE, RA and RA-C

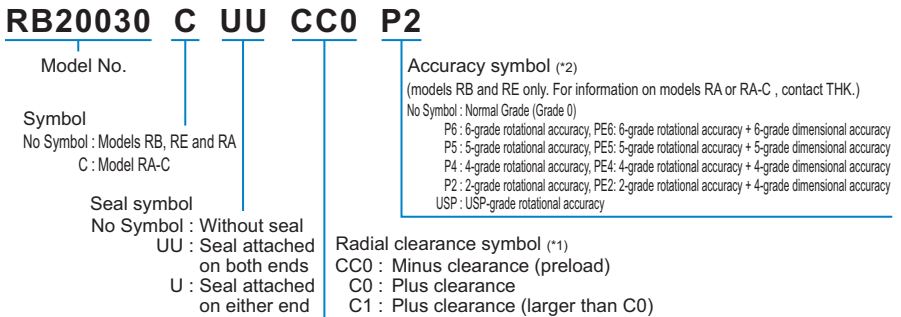

(\*1) See **▣18-17**. (\*2) See **▣18-12** to **▣18-16**.

## [Handling]

- (1) Please use at least two people to move any product weighing 20 kg or more, or use a dolly or another conveyance. Doing so may cause injury or damage.
- (2) The inner and outer rings, which are comprised of two parts, are held together with a special rivet or screws, so install as is. Incorrect installation of the spacer retainer will greatly affect rotational performance, do not disassemble the Cross Roller Ring.
- (3) Take care not to drop or strike the Cross Roller Ring. Doing so may cause injury or damage. Giving an impact to it could also cause damage to its function even if the product looks intact.
- (4) When handling the product, wear protective gloves, safety shoes, etc., as necessary to ensure safety.

## [Precautions on Use]

- (1) Prevent foreign material, such as cutting chips or coolant, from entering the product. Failure to do so may cause damage.
- (2) If the product is used in an environment where cutting chips, coolant, corrosive solvents, water, etc., may enter the product, use bellows, covers, etc., to prevent them from entering the product.
- (3) Do not use the product at temperature of 80°C or higher. Exposure to higher temperatures may cause the resin/rubber parts to deform/be damaged.
- (4) If foreign material such as cutting chips adheres to the product, replenish the lubricant after cleaning the product.
- (5) Slight rocking can inhibit the formation of a film of oil between the rolling surface and the area of contact, resulting in fretting. THK recommends periodically rotating the cross roller ring several times to help ensure that a film forms on the surfaces and rolling elements.
- (6) Do not use undue force when fitting parts (pin, key, etc.) to the product. This may generate permanent deformation on the raceway, leading to loss of functionality.
- (7) The matching mark of the inner or outer ring may be slightly misaligned when delivered. In that case, loosen the bolts that secure the inner or outer ring, and correct the alignment using a plastic hammer or the like, before installing it to the housing. (Let the securing rivets follow the housing.)
- (8) When installing the Cross-Roller Ring, insert the ring by hammering the ring that is to be fixed (i.e. hammer the inner ring if the inner ring is to be fixed, or hammer the outer ring if the outer ring is to be fixed). Hammering the ring on the wrong side may cause damage.
- (9) Insufficient rigidity or accuracy of mounting members causes the bearing load to concentrate on one point, and the bearing performance will drop significantly. Accordingly, give sufficient consideration to the rigidity/accuracy of the housing and base and strength of the fixing bolts.
- (10) When installing or removing the Cross Roller Ring, do not apply force to the fixing rivets or the bolts.
- (11) When mounting the presser flange, take into account the dimensional tolerances of the parts so that the flange firmly holds the inner and outer rings from the side.

**[Lubrication]**

- (1) Do not mix different lubricants. Mixing greases using the same type of thickening agent may still cause adverse interaction between the two greases if they use different additives, etc.
- (2) When using the product in locations exposed to constant vibrations or in special environments such as clean rooms, vacuum and low/high temperature, use the grease appropriate for the specification/environment.
- (3) The consistency of grease changes according to the temperature. Take note that the torque of the Cross Roller Ring also changes as the consistency of grease changes.
- (4) Since each Cross Roller Ring unit contains high-quality lithium soap group grease No. 2, initial greasing is not needed. However, the product requires regular lubrication since it has a smaller internal space than ordinary roller bearings and because the rollers need frequent lubrication due to their rolling contact structure.

To replenish grease, it is necessary to access greasing holes that lead to the oil grooves formed on the inner and outer rings. As for the lubrication interval, normally replenish the same type of grease so that it is distributed throughout the interior at least every three to six months. Set the final lubrication interval/amount based on the actual machine.

When the bearing is filled up with grease, the initial rotational torque temporarily increases due to grease resistance. However, surplus grease will run off of the seals and the torque will return to the normal level in a short period. The thin type does not have an oil groove. Secure an oil groove in the inner diameter side of the housing for lubrication.

**[Storage]**

When storing the Cross Roller Ring, enclose it in a package designated by THK and store it in a room in a horizontal orientation while avoiding high temperature, low temperature and high humidity. After the product has been in storage for an extended period of time, lubricant inside may have deteriorated, so add new lubricant before use.

**[Disposal]**

Dispose of the product properly as industrial waste.

